



FINESIA™

BL Implant (Prosthesis) Manual

* The pictures are concept images.

FINESIA BL Implant (Prosthesis) Manual Table of Contents

| | |
|--|-----------------|
| 1. Overview | 2 to 15 |
| 1 Bone level (BL) implant system | 2 |
| 2 Design of the connection | 3 |
| 3 Superstructure | |
| 3-1 Types of implant superstructures | 4 |
| 3-2 Cement-retained superstructure | 5 |
| 3-3 Screw-retained superstructure | 5 |
| 3-4 Overdenture superstructure | 6 to 7 |
| 3-5 List of superstructure parts | 8 to 10 |
| 3-6 Types of prostheses and superstructure parts | 11 to 12 |
| 3-7 Precautions for the intraoral attachment of superstructure parts | 13 |
| 3-8 Intraoral attachment of superstructure parts | 14 |
| 3-9 Color codes | 15 |
| 2. Treatment plan | 16 to 17 |
| 1 Wax-up/diagnostic cast | 16 |
| 2 X-ray template | 16 |
| 3 Surgical template | 17 |
| 3. Gingival management | 18 to 26 |
| 1 Healing abutment | 19 to 24 |
| 2 Custom healing abutment | 25 to 26 |
| 4. Impression taking | 27 to 46 |
| 1 Impression techniques | 27 |
| 2 Impression level | 28 |
| 3 Direct impression | 29 |
| 4 Open tray impression technique (implant level) | 30 to 32 |
| 5 Closed tray impression technique (implant level) | 32 to 35 |
| 6 Open tray impression technique (abutment level) | 36 to 39 |
| 7 Closed tray impression technique (abutment level) | 40 to 42 |
| 8 Digital impression technique | 43 to 46 |
| 5. Provisional restoration | 47 to 50 |
| 1 Temporary abutment | 47 to 50 |
| 6. Cement-retained superstructure | 51 to 64 |
| 1 Post abutment | 51 to 53 |
| 2 Angle abutment/preparable abutment | 54 to 58 |
| 3 Cast-on abutment | 59 to 64 |
| 7. Screw-retained superstructure | 65 to 80 |
| 1 Splint abutment | 65 to 75 |
| 2 Cast-on abutment | 76 to 80 |
| Technical information on the welding technique | 81 to 82 |
| 8. Custom abutment manufactured using CAD/CAM | 83 to 86 |
| 1 Titanium-based abutment | 83 to 86 |
| 9. Overdenture | 87 to 98 |
| 1 Overdenture | 87 |
| 2 Splint abutment | 88 to 94 |
| 3 Ball abutment | 95 to 98 |

1. Overview

1 Bone level (BL) implant system

BL fixture can be inserted using the non-submerged or submerged technique. These are particularly suitable for regions with a high esthetic demand.

BL implants exhibit a 17° tapered hex connection. The tapered or straight implant body consists of a body thread with a pitch of 0.8 mm and a microthread with a pitch of 0.4 mm.

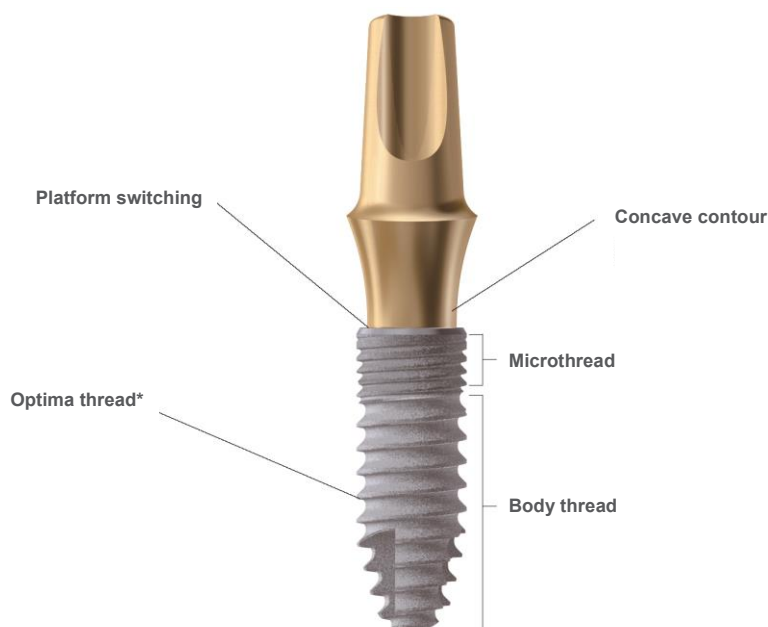

Optima thread*

The optima thread is designed on the body thread.

*The term optima thread was coined by combining the terms optimum and thread.

Platform switching

An abutment with a diameter smaller than that of the implant body provides a space that allows gingival tissues to grow faster than bones and suppresses bone resorption near the bone crest.

Concave contour

In light of tissue management, the abutment cuff is designed with a concave contour.

2 Design of the connection

BL fixture exhibit a tapered hex connection.

This connection is designed as a 17° tapered joint (8.5° on one side) with a hexagonal antirotation mechanism. The design promises excellent blocking performance and operability.

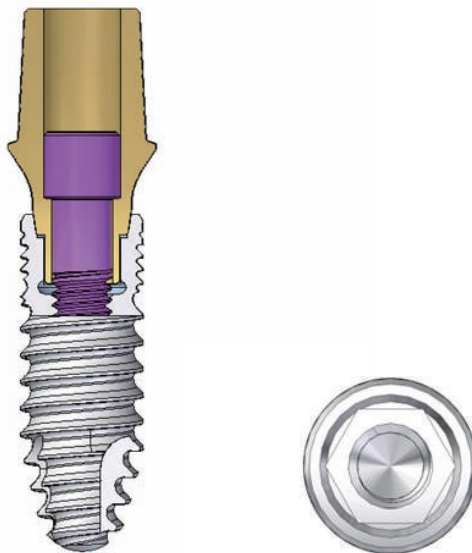

3 Superstructure

3-1 Types of implant superstructures

The superstructure for an implant-supported denture can be selected according to the conditions and requests of individual patients as well as functional and esthetic requirements. Superstructures can be classified into cement-retained and screw-retained superstructures on the basis of the fixing technique.

A cement-retained superstructure appears esthetic because its crown has no access hole. This type of superstructure can be manufactured using the same technique employed for conventional crown or bridge work.



However, with a cement-retained superstructure, some amount of clearance is required between the implant and opposing tooth for retention. Therefore, it is necessary to select the cuff or set the margin after considering the excessive cement required for retention.

A screw-retained superstructure can be removed by the operator, and its crown has an access hole for placing the screw. This type of superstructure can be attached and removed by tightening and loosening the screw, respectively; therefore, it is suitable for cases where maintenance is of utmost importance. Even if there is not much longitudinal clearance between the implant and opposing tooth, an adequate retentive force can be maintained because a screw is used for retention.

Patient-removable superstructures include overdentures and use the implants for anchorage.

A complete understanding of the characteristics of these superstructures and selection of the appropriate type for each case are important.

Advantages and disadvantages of superstructures

| Technique | Cement-retained superstructure | Screw-retained superstructure | Overdenture |
|---------------|---|--|---|
| |  |  |  |
| Advantages | <ul style="list-style-type: none"> The manufacturing technique is similar to conventional prosthetic techniques. Stronger retention is achieved with the use of cement as the interface. It appears esthetic because of the absence of an access hole. | <ul style="list-style-type: none"> The superstructure is removable. Retention is ensured even if the axial plane is short. The addition of a gingival portion compensates for deficient soft tissues. | <ul style="list-style-type: none"> It allows for the formation of an appropriate dental arch. The addition of a denture border compensates for deficient soft tissues. <p>[Overdenture with bar attachment]</p> <ul style="list-style-type: none"> An excellent retentive force is obtained. A rotative force can be applied to the implant bodies. <p>[Overdenture with ball attachment]</p> <ul style="list-style-type: none"> It is easy to operate. An easily removable overdenture (patient removable) can be manufactured. The structure allows for the correction of angles up to 40° between implants Combination with the designated attachments allows for adjustment of the retentive force. |
| Disadvantages | <ul style="list-style-type: none"> Residual cement should be carefully assessed. Retention is difficult to ensure if the axial plane is short or severely tilted. | <ul style="list-style-type: none"> Achievement of a passive fit is difficult. Esthetics are compromised because of the presence of an access hole. | <ul style="list-style-type: none"> The denture covering impairs the self-cleaning function of areas surrounding the implants. The palatal/lingual plate causes discomfort. Clearance is required. |

3-2 Cement-retained superstructure

A cement-retained superstructure is composed of a ready-made post and a custom abutment manufactured by grinding and welding. Both are attached to the implant for fixation of the final prosthesis with cement.

Features of a cement-retained superstructure

- A cement-retained superstructure can be manufactured using a technique similar to the conventional prosthetic technique.
- Stronger retention is achieved with the use of cement as the interface.
- It is esthetic.

Precautions for use

Residual cement should be carefully assessed.

The position of the margin for the final prosthesis should be carefully set. Retention of the final prosthesis may be impaired if there is no clearance between the implant and opposing tooth and if the axial plane of the post is short or severely tilted. A cement-retained superstructure is not recommended for such cases.



Indicated abutments

Post abutment, angle abutment, prepeable abutment, titanium-based abutment or cast-on abutment

3-3 Screw-retained superstructure

A screw-retained superstructure is manufactured by fixation of the final superstructure to the implant body with a screw.

Features of a screw-retained superstructure

- The superstructure can be removed by the operator.
- An adequate retentive force can be maintained even if there is no clearance between the implant and opposing tooth and the axial plane is short.
- The addition of a gingival portion compensates for deficient soft tissues.

Precautions for use

It is necessary to achieve a passive fit between the final superstructure and implant body. Appropriate parts should be selected, with great attention to their design.

Indicated abutments

Splint abutment, titanium-based abutment or cast-on abutment



Overdenture superstructure

An overdenture is a removable denture that supported by implant body.

When it is used in combination with an abutment that has an attachment mechanism, stable retention is ensured because the abutment serves as an anchor. Functional improvement is greater with this type of superstructure than with a conventional full denture. A [1] bar or [2] ball attachment can be selected as an attachment for this system. During selection of the attachment, the thickness of artificial teeth, clearance, and alveolar ridge condition should be taken into consideration. However, the attachment for an overdenture only aids in retention of the denture; therefore, careful designing of the basic denture is more important.

■ Overdenture with a bar attachment

When an overdenture with a bar attachment is used, the implants are coupled, which allows the application of a rotative force to the implant bodies.

This type of overdenture is suitable for cases with a severely absorbed alveolar ridge and no undercut. The denture is fixed with a bar attachment placed on the implant bodies and an attachment mounted on the denture.

Features of an overdenture with a bar attachment

- The retentive force is excellent.
- A rotative force can be applied to the implant bodies.

Precautions for use

If parallelism between implants is lost, it is difficult to fix a bar attachment. A splint abutment is recommended for such cases.

It is difficult to use a bar attachment if the implant bodies are located medially, far from the alveolar crest. The implant position and direction should be carefully considered.

Cleaning of the underside of a bar attachment is more difficult than cleaning of the undersides of other attachments.

Indicated abutments

Splint abutment



■ Overdenture with ball attachments

In an overdenture with ball attachments, the denture is fixed with abutments with \varnothing 2.25-mm balls for retention and the housing type (female part) mounted on the denture.

FINESIA ball abutments can be used in combination with the designated attachments.

Features of an overdenture with ball attachments

- It is easy to operate.
- An easily removable overdenture (patient removable) can be manufactured.
- The structure allows for the correction of angles up to 40° between implants.
- Combination with the designated attachments allows for adjustment of the retentive force.

(Adjustment range: approximately 200 g to 1200 g)



Precautions for use

At least two implant bodies should be inserted. The number of implants should be determined depending on the case. This type of abutment cannot be used if the angle between implants is larger than 40°. The implant bodies should be carefully inserted.

Dentures with ball attachments are mucosa-borne dentures; consequently, some degree of intraoral movement is inevitable. Denture setting should be done with the same amount of care taken for conventional dentures.

Indicated abutments

Ball abutment

3-5 List of superstructure parts

3-5-1 NP: narrow platform ϕ 3.2 mm/3.4 mm

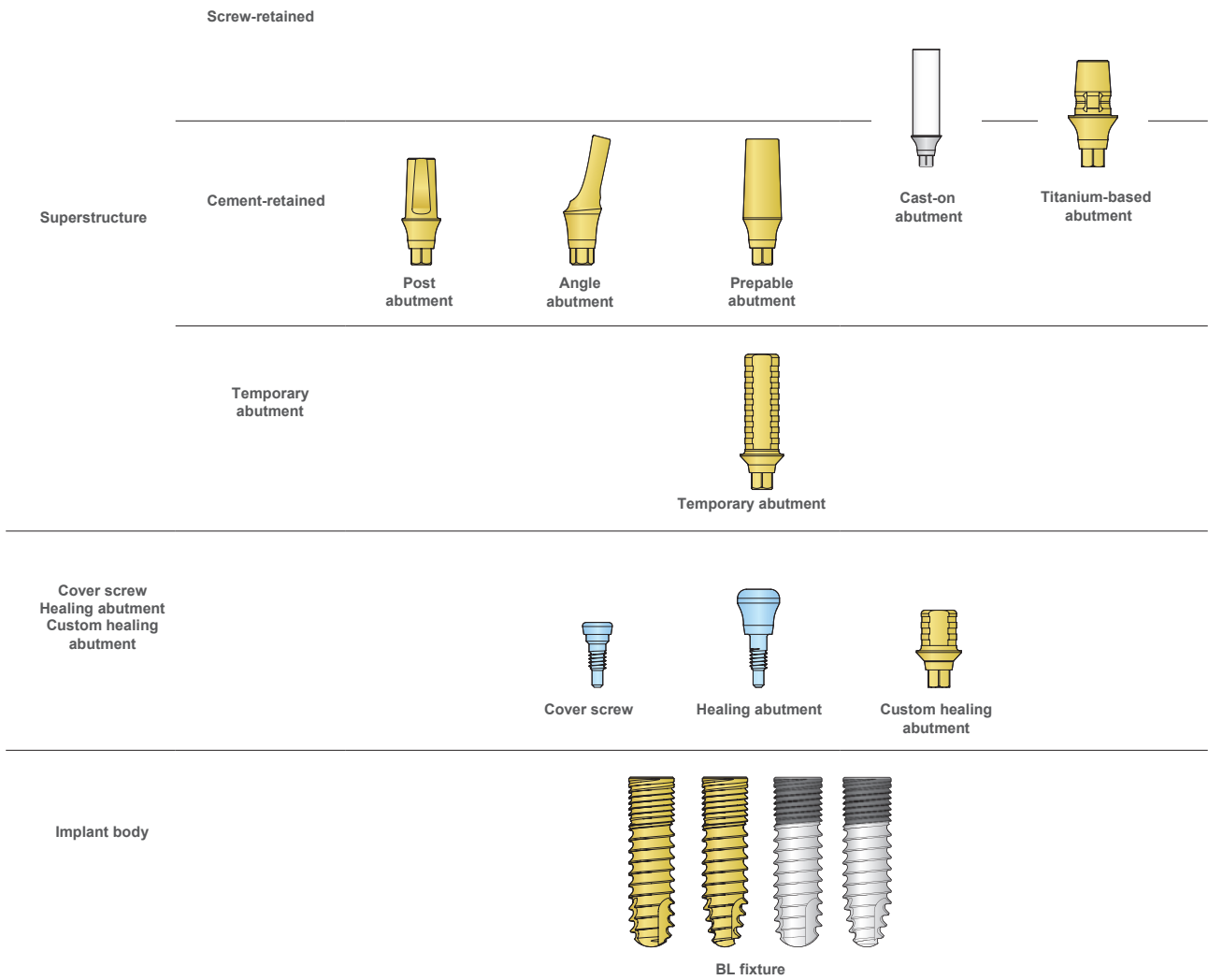

3-5-2 RP: regular platform ϕ 3.7 mm/4.2 mm

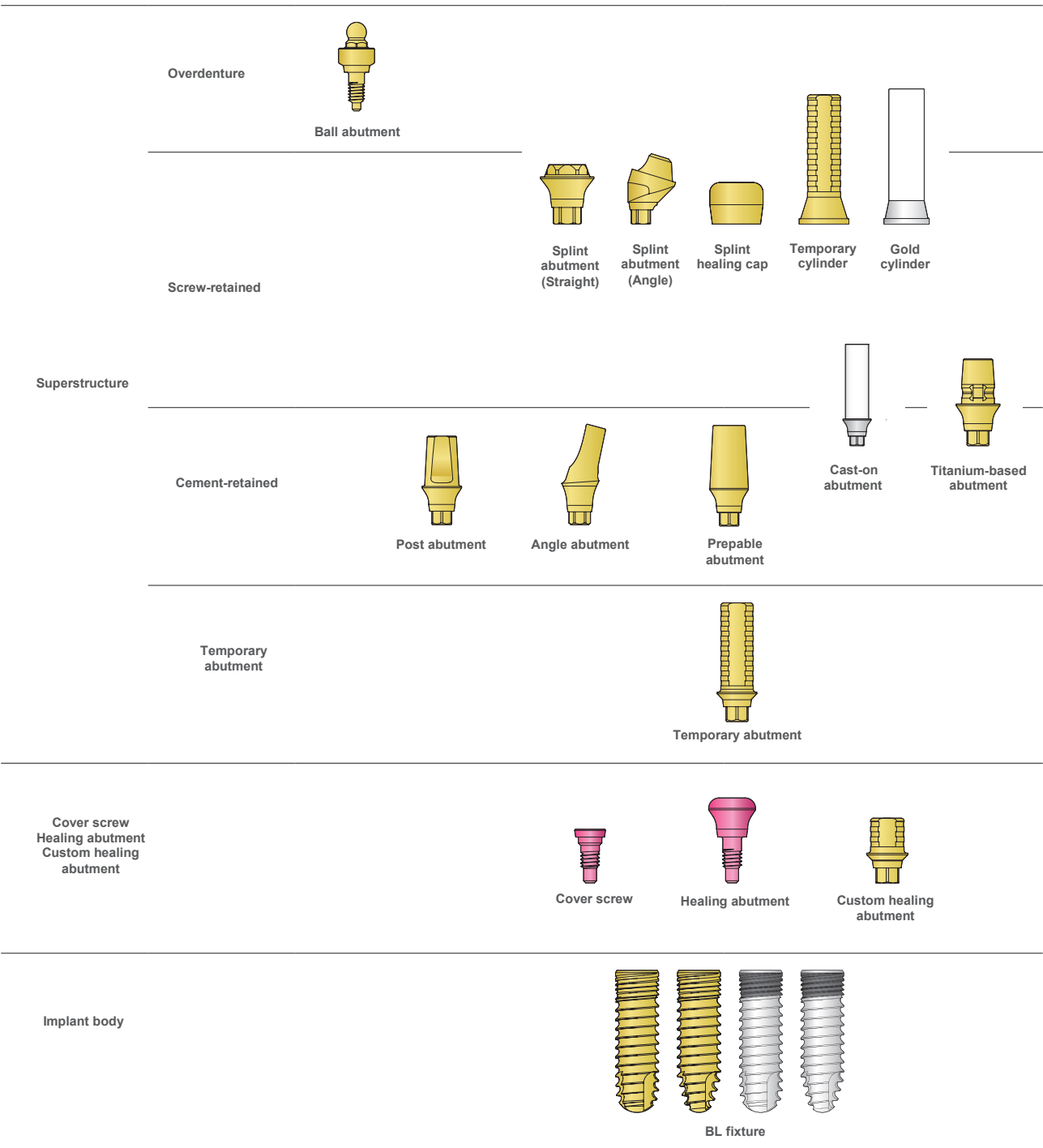

3-5-3 WP: wide platform ϕ 4.7 mm/5.2 mm

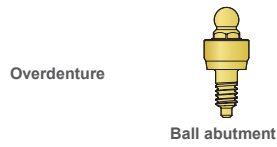

Screw-retained

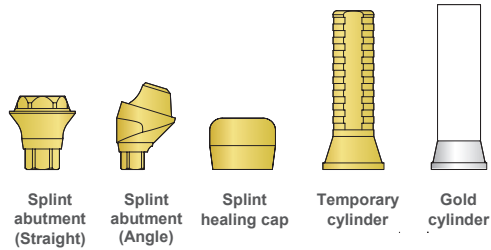

Superstructure

Cement-retained

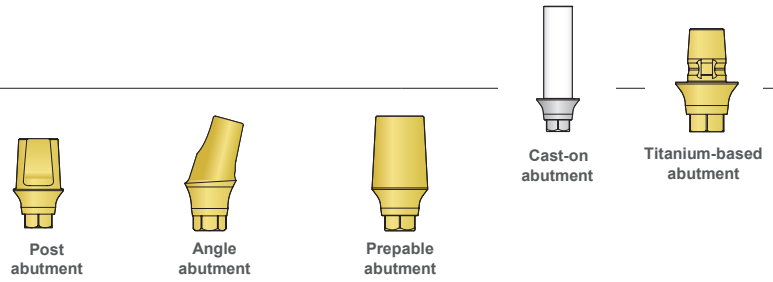

Temporary abutment

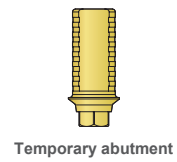

Cover screw
Healing abutment
Custom healing abutment



Implant body

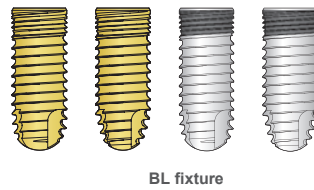

3-6 Types of prostheses and superstructure parts

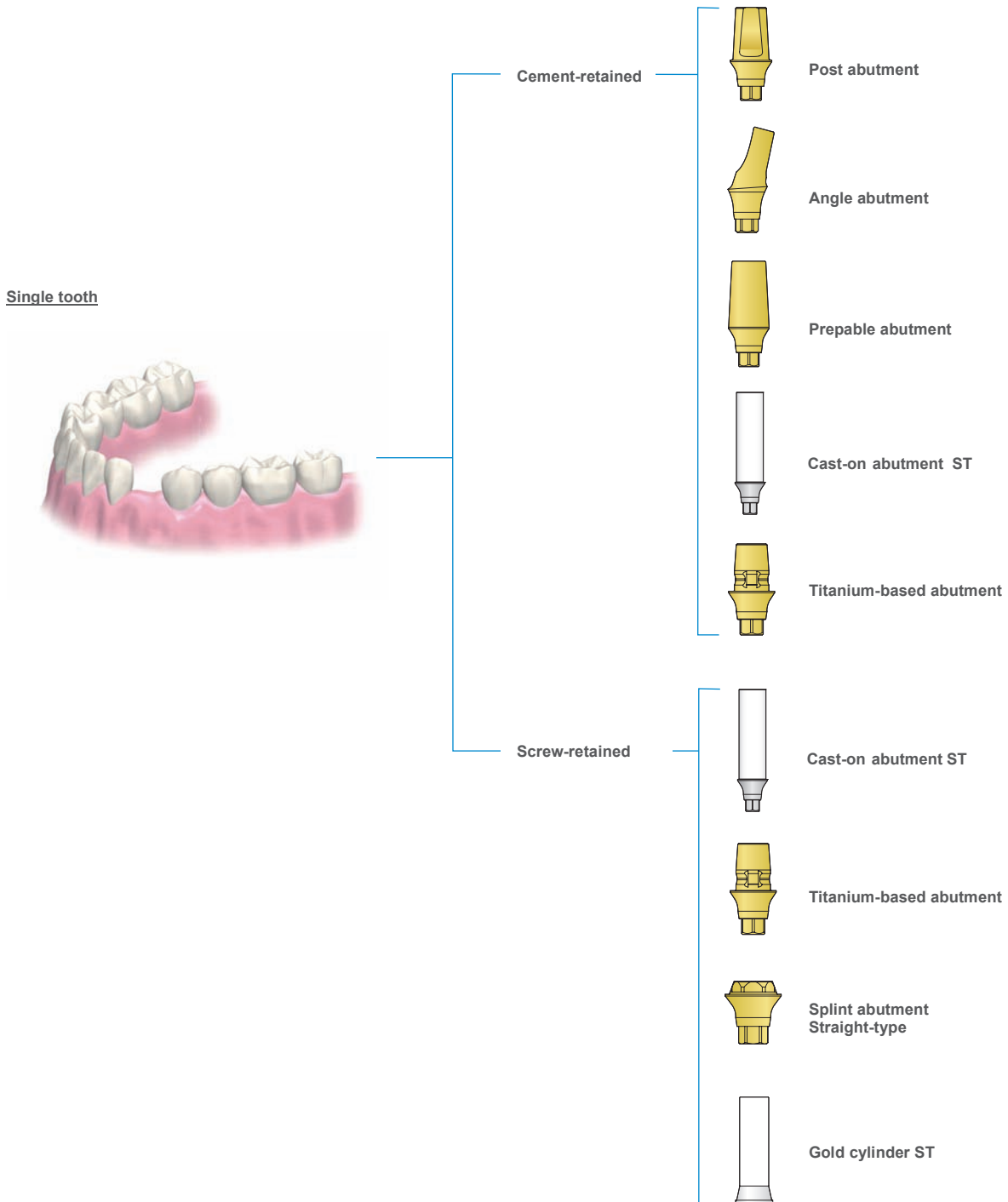

*For inquiries about prosthesis manufacture using the dental CAD/CAM system, contact us.

Bridge

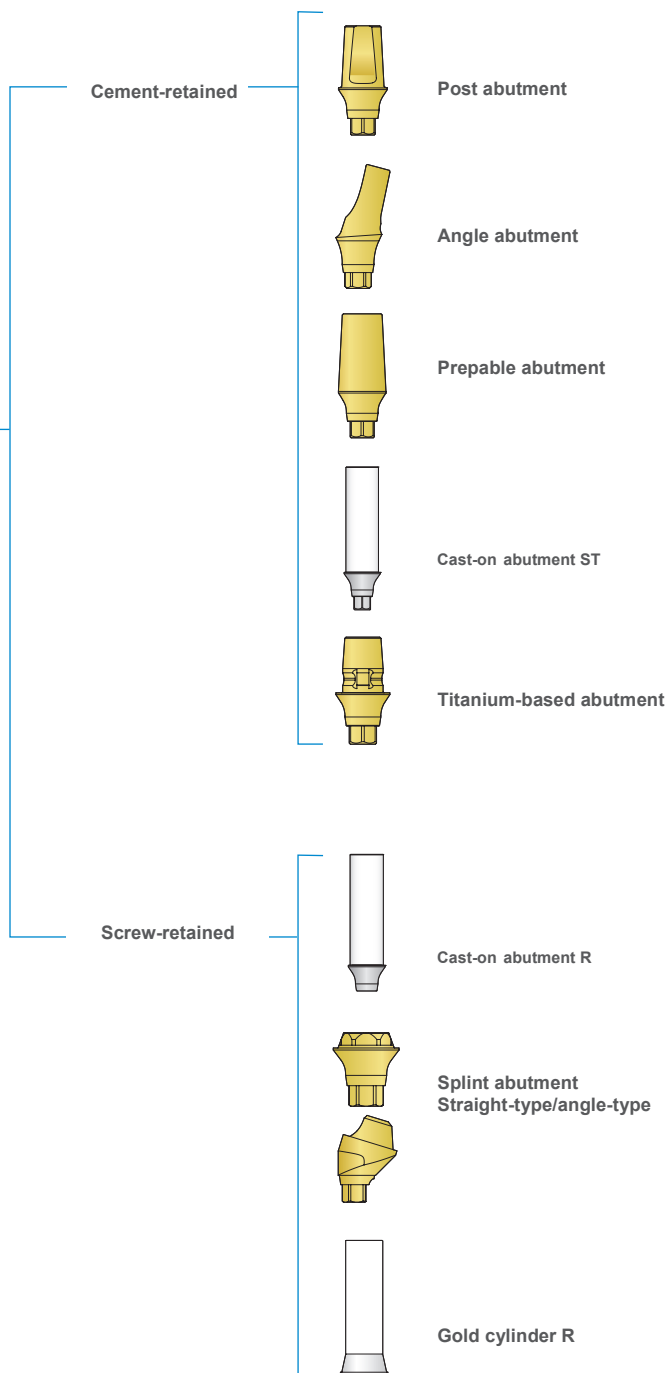

*For inquiries about prosthesis manufacture using the dental CAD/CAM system, contact us.

*For a screw-fixed bridge or a bar attachment, use splint abutments to achieve a passive fit.

Overdenture

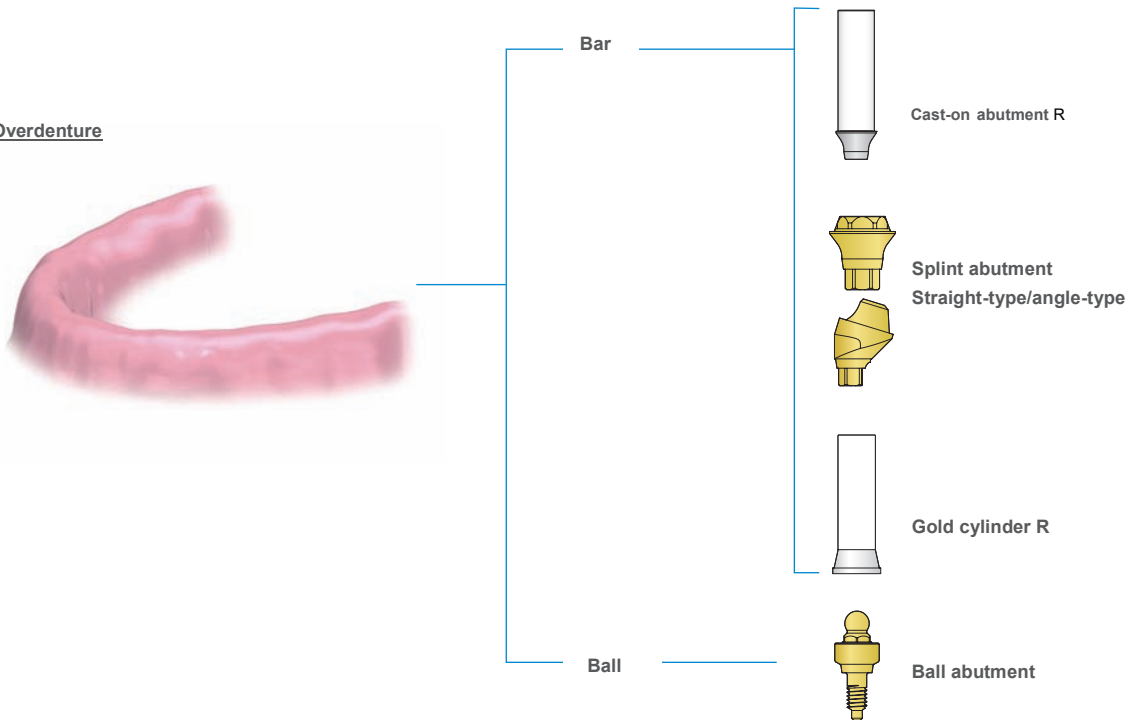

*For inquiries about prosthesis manufacture using the dental CAD/CAM system, contact us.
 *For a screw-fixed bridge or a bar attachment, use splint abutments to achieve a passive fit.

3-7 Precautions for the intraoral attachment of superstructure parts

Attachment of the abutment in the correct position greatly affects the long-term prognosis. Confirm whether the abutment is accurately attached.

[Basic procedure for attaching the abutment]

1. Attach the abutment to the implant body and carefully rotate it to ensure that the hexagonal antirotation mechanism at the tip of the abutment is properly fitted.
2. Ensure that the abutment is properly attached in the horizontal and vertical directions.
3. Temporarily tighten the screw. (At this point, do not fully tighten the screw at a final torque.)
4. Check that the abutment is accurately attached to the implant body by X-ray.
 - The implant body should be longitudinally parallel to the abutment.
 - There should be no clearance between the implant body and abutment joint surface.
 - The surrounding bone should not interfere with the abutment.
5. Tighten the abutment screw at a final torque.

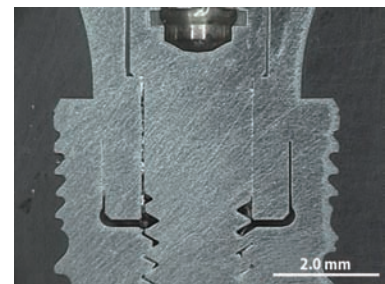



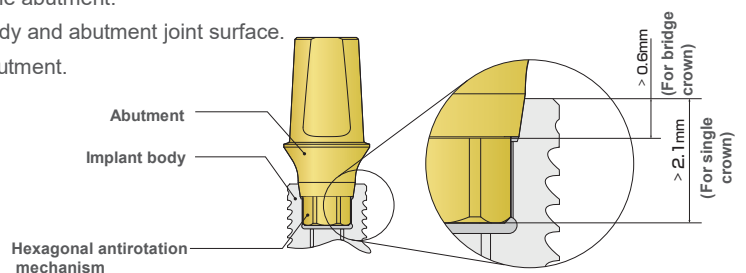







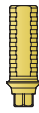







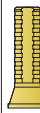





Cross-sectional image of the connection with a BL implant



3-8 Intraoral attachment of superstructure parts

For each of the superstructure parts in BL implants, the sterilization condition, tightening method and torque, and fixture driver are specified.

| Product name | Healing abutment | Custom healing abutment | Temporary abutment | Post abutment | Angle abutment | Prepable abutment | Cast-on abutment | Titanium-based abutment | Splint abutment (Straight) | Splint abutment (Angle) | Splint healing cap | Temporary abutment/gold cylinder | Ball abutment |
|-------------------------------------|---|---|---|---|---|---|---|---|---|---|---|---|---|
| Product drawing |  |  |  |  |  |  |  |  |  |  |  |  |  |
| Sterilization condition | Sterilized | Non-sterilized | Non-sterilized | Non-sterilized | Non-sterilized | Non-sterilized | Non-sterilized | Non-sterilized | Sterilized | Sterilized | Non-sterilized | Non-sterilized | Non-sterilized |
| Tightening method/ torque (N·cm) | NP | Manual | Manual | 20 | 20 | 20 | 20 | 20 | — | — | — | — | — |
| | RP | | | 30 | 30 | 30 | 30 | 30 | 30 | 20 | Manual | 20 | 30 |
| | WP | | | | | | | | | | | | |
| Driver |  |  |  |  |  |  |  |  |  |  |  |  |  |
| | Hexalobular driver SH | Hexalobular driver SH | Hexalobular driver CH | Hexalobular driver CH | Hexalobular driver CH | Hexalobular driver CH | Hexalobular driver CH | Hexalobular driver CH | Driver for splint abutment | Flex driver CH | Flex driver CH + CH adapter | Flex driver CH | Ball abutment driver |

[Remarks]

*For superstructure parts with “Manual” specified as the tightening method, the parts should be manually tightened.

Important

Before attaching a healing abutment, temporary abutment, or superstructure part to the implant body, check the tightening method and recommended tightening torque for each part.

Notes

- Before attaching Non-sterilized products in the oral cavity, make sure to sterilize them.
- Examples of sterilization conditions

(For retention temperature and time, refer to the right table, ISO 17665-2 (Sterilization of health care products - Moist heat - Part 2 : Guidance on the application of ISO 17665 Part 1 : 2006))



















- For intraoral attachment of a superstructure part, fix it on the implant body at the tightening torque specified for the particular part.

Autoclave conditions

| Retention temperature | Retention time |
|-----------------------|----------------|
| 121°C | 15 minutes |
| 126°C | 10 minutes |
| 134°C | 3 minutes |

3-9 Color codes

For BL fixture, individual parts such as the cover screw, healing abutment, impression part, analog, and abutment screw are color coded or marked by a platform. (Unit: mm)

| | Diameter of implant abutment joint (φ) | Diameter of compatible implant | Cover screw | Healing abutment | Impression post | Transfer coping | Analog | Abutment screw |
|----|--|--------------------------------|---|---|---|---|---|---|
| NP | 2.45 | 3.2/3.4 |  |  |  |  |  |  |
| RP | 2.95 | 3.7/4.2 |  |  |  |  |  |  |
| WP | 3.75 | 4.7/5.2 |  |  |  |  |  |  |

3-10 Precautions for the use of superstructure parts

- 1) Fix the abutment after confirming that the soft tissues and bone have healed at least 3 months after insertion of the implant bodies in the mandible or at least 6 months after insertion of the implant bodies in the maxilla.
- 2) Some of the abutments are Non-sterilized. Check whether the indicated abutment is sterilized before use.
- 3) Obtain X-ray images as needed to check for clearance between the abutment and implant.
- 4) Before attaching the abutment, thoroughly clean the implant body to eliminate foreign material such as blood.
- 5) Use a lab screw as needed for laboratory work. Do not confuse the lab screw with the abutment screw and the cylinder screw, because both have the same shape.
- 6) The tightening torque for a tightened screw is slightly decreased because of initial plastic deformation of the screw itself. Retightening is required to restore the original torque and establish a closer connection between parts to prevent loosening. Ret Non-sterilized ighten the abutment screw two to three times.
- 7) Use an alternatively available abutment screw at the time of replacement during maintenance.
- 8) Do not store the products in an area exposed to high temperature, humidity, or direct sunlight. An implant body dropped on the floor or contaminated by foreign material such as saliva can be infected. Please discard it immediately.
- 9) When tightening the abutment or operating a dedicated tool, be careful so that the patient does not accidentally swallow the abutment.
- 10) The abutment may be deformed or damaged if excessive force is applied.
- 11) Check the package before opening it. Don't use the abutment if the package is damaged.
- 12) Do not use any tool other than dedicated ones, otherwise you can damage the implant body.
- 13) The maximum period of use for custom healing abutments, temporary abutments, and temporary cylinders is 2 months.
- 14) The cover screw, healing abutment, custom healing abutment, temporary cylinder, and splint healing cap are provisional parts. Avoid the application of bite forces to these parts.
- 15) Carefully read the package inserts and fully understand the functions of products, methods of use, and surgical procedures before use.

2. Treatment plan

In implant treatment, development of a proper treatment plan based on comprehensive exploration and diagnosis is very important. Implant positioning is important for the manufacture of a functional, esthetic, and clean superstructure. For accurate implant positioning, it is essential to prepare a template.

Preparation of a template provides information regarding the correct implant position as well as information necessary for designing the superstructure.

1 Wax-up/diagnostic cast

A diagnostic wax-up should be fabricated on a study model, and the three-dimensional position and direction for placement of the implant body, type and size of the implant body, and a suitable superstructure should be selected on the basis of the wax-up.

The diagnostic wax-up/model can be used for the fabrication of a diagnostic template or surgical template using X-rays and the provisional restoration.



Technical points

- A study model should be mounted on an articulator and wax-up in order to check the size of the crown, adjacent teeth, opposing dentition, and relationship with the opposing teeth.

2 X-ray template

A diagnostic template is fabricated from X-rays to check the bone mass in the planned region of implant body placement and anatomical conditions such as the bone height and diameter.

The determined implant position is marked on a model, and a wax-up is prepared from material such as clear resin.

Then, a radiopaque metal pin, ball, or stopping is placed at the determined implant position.

The X-ray template can be used to select the size and type of implant body, because the bone mass, shape of the alveolar ridge, and thickness of the mucosa in the planned region of implant body placement can be checked on the X-ray images and CT images acquired with the template.



Technical points

- Set the occlusal condition and guidance with reference to a diagnostic wax-up so that excessive stress is not applied in the planned region of implant body placement.
- To determine the implant position and direction, please refer to the following information: [1] mesiodistal relationship, [2] buccolingual relationship, [3] orientation of the adjacent tooth roots, [4] occlusal plane, and [5] residual buccolingual bone mass.

3 Surgical template

A surgical template is fabricated after the position of implant body placement is successfully checked using the diagnostic template. The use of a surgical template enables correct planning and creation of implant holes.

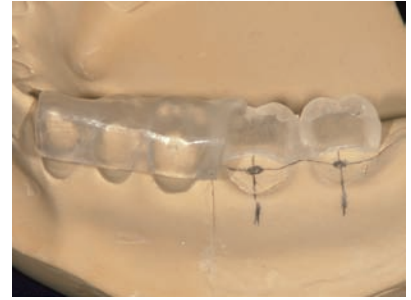

3. Gingival management

BL implant bodies are designed with importance given to esthetic quality. The cuff of the healing abutment indicated for gingival management is available in various sizes and concave contours; this enables consistent gingival management.

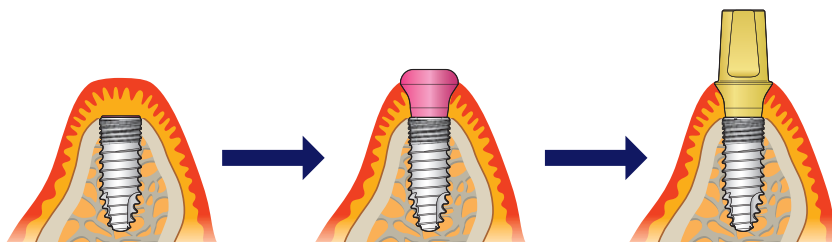

Abutments indicated for gingival management

Healing abutment



Custom healing abutment



Temporary abutment

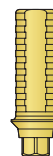

1 Healing abutment

- ◆ Intended use
 - Gingival management

- ◆ Material
 - Titanium alloy (Ti-6Al-4V ELI)

- ◆ Selection criteria
 - Thickness of the gingiva
 - Size of the final prosthesis
 - Type of the final superstructure

- ◆ Tightening method
 - Manual (manual tightening)

- ◆ Indicated driver
 - Hexalobular driver SH

- ◆ Sterilization condition
 - Sterilized

Healing abutment

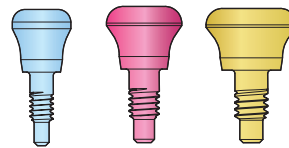

Variations in the healing abutment size

(Unit: mm)











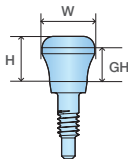





























| | | Diameter of compatible implant (φ) | Height (H) | Cuff height (GH) | Diameter (W) | |
|--|----|------------------------------------|------------|------------------|--------------|------|
| | | | | | Standard | Wide |
| | NP | 3.2/3.4 | 2.0 | 1.0 | 3.5 | 4.0 |
| | | | 3.0 | 2.0 | | |
| | | | 4.0 | 3.0 | | |
| | | | 5.0 | 4.0 | | |
| | | | 6.0 | 5.0 | | |
| | RP | 3.7/4.2 | 2.0 | 1.0 | 4.5 | 5.0 |
| | | | 3.0 | 2.0 | | |
| | | | 4.0 | 3.0 | | |
| | | | 5.0 | 4.0 | | |
| | | | 6.0 | 5.0 | | |
| | WP | 4.7/5.2 | 2.0 | 1.0 | 5.5 | 6.0 |
| | | | 3.0 | 2.0 | | |
| | | | 4.0 | 3.0 | | |
| | | | 5.0 | 4.0 | | |
| | | | 6.0 | 5.0 | | |

Reference table for compatibility between healing abutments and superstructure parts

The BL implant system is designed to reproduce the gingival penetration configuration of the healing abutment when the optimal combination of the healing abutment and superstructure part is selected.











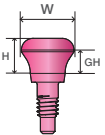

NP (Diameter of implant body (φ): 3.2/3.4)

(Unit: mm)

| NP | | | | Post abutment | Angle abutment | Prepable abutment | Temporary abutment | Cast-on abutment | Titanium-based abutment | Transfer coping | Impression post | | |
|--|---|-------------------------|---|---------------|---|---|---|---|---|--|--|--|---|
| Healing abutment  |  | Standard | 2.0 | 1.0 |  | |  |  | | | | | |
| | | | 3.0 | 2.0 |  |  |  |  |  |  | | | |
| | | | 4.0 | 3.0 |  |  |  |  | | |  | | |
| | | | 5.0 | 4.0 |  |  |  |  | | | | | |
| | | | 6.0 | 5.0 |  |  |  |  | | | |  |  |
| | | | | | | | | | | | | | |
| | | Wide | 2.0 | 1.0 | | |  | | | | | | |
| | | | 3.0 | 2.0 | |  |  | | | | | | |
| | | | 4.0 | 3.0 | |  |  | | | | | | |
| | | | 5.0 | 4.0 | |  |  | | | | | | |
| | | | 6.0 | 5.0 | |  |  | | | | | | |
| | | Custom healing abutment |  | | | | |  |  |  |  |  | |
| | | Remarks | | | | | | | | In case a healing abutment with a height of 3–6 mm is used, the gingiva may be cut open at the time of attachment. | In case a healing abutment with a height of 3–6 mm is used, the gingiva may be cut open at the time of attachment. | The emergence angles of transfer coping S and transfer coping L are the same as those of healing abutments with heights of 4.0 and 6.0 mm, respectively. | The emergence angle of the impression post is the same as that of a healing abutment with a height of 6.0 mm. |

RP (Diameter of implant body (φ): 3.7/4.2)

(Unit: mm)

| RP | | | | Post abutment | Angle abutment | Prepable abutment | Temporary abutment | Cast-on abutment | Titanium-based abutment | Splint abutment | Ball abutment | Transfer coping | Impression post | | | |
|-------------------------|---|--------------------|---|---------------|---|---|---|--|--|--|---|--|---|---|---|--|
| Healing abutment |  | Standard | 2.0 | 1.0 |  |  |  |  |  |  |  |  |  |  | | |
| | | | 3.0 | 2.0 | ● | ● | ● | ● | ● | ● | | | | | | |
| | | | 4.0 | 3.0 | ● | ● | ● | ● | | | | | ● | | | |
| | | | 5.0 | 4.0 | ● | ● | ● | ● | | | | | | ● | | |
| | | | 6.0 | 5.0 | ● | ● | ● | ● | | | | | | ● | ● | |
| | | | | | | | | | | | | | | | | |
| | | Wide | 2.0 | 1.0 | ● | | ● | | | | | | | | | |
| | | | 3.0 | 2.0 | ● | ● | ● | | | | | | | | | |
| | | | 4.0 | 3.0 | ● | ● | ● | | | | | | | | | |
| | | | 5.0 | 4.0 | ● | ● | ● | | | | | | | | | |
| | | | 6.0 | 5.0 | ● | ● | ● | | | | | | | | | |
| | | Custom healing cap |  | | | | | | ● | ● | ● | ● | ● | ● | ● | |
| Splint Healing abutment |  | | | | | | | | | ● | | | | | | |
| Remarks | | | | | | | | In case a healing abutment with a height of 3-6 mm is used, the gingiva may be cut open at the time of attachment. | In case a healing abutment with a height of 3-6 mm is used, the gingiva may be cut open at the time of attachment. | A splint abutment is used in combination with a splint healing cap during secondary surgery. | A custom healing abutment should be attached to a ball abutment. | The emergence angles of transfer coping S and transfer coping L are the same as those of healing abutments with heights of 4.0 and 6.0 mm, respectively. | The emergence angle of the impression post is the same as that of a healing abutment with a height of 6.0 mm. | | | |

3. Gingival management

WP (Diameter of implant body (ϕ): 4.7/5.2)

(Unit: mm)

| WP | | | | Post abutment | Angle abutment | Prepable abutment | Temporary abutment | Cast-on abutment | Titanium-based abutment | Splint abutment | Ball abutment | Transfer coping | Impression post | | |
|-------------------------|--|----------|-----|---------------|----------------|-------------------|--------------------|--|--|--|--|--|---|---|--|
| Healing abutment | | Standard | 2.0 | 1.0 | | | | | | | | | | | |
| | | | 3.0 | 2.0 | ● | ● | ● | ● | ● | ● | | | | | |
| | | | 4.0 | 3.0 | ● | ● | ● | ● | | | | | ● | | |
| | | | 5.0 | 4.0 | ● | ● | ● | ● | | | | | | | |
| | | | 6.0 | 5.0 | ● | ● | ● | ● | | | | | ● | ● | |
| | | | 6.0 | 5.0 | ● | ● | ● | | | | | | | | |
| | | Wide | 2.0 | 1.0 | ● | | ● | | | | | | | | |
| | | | 3.0 | 2.0 | ● | ● | ● | | | | | | | | |
| | | | 4.0 | 3.0 | ● | ● | ● | | | | | | | | |
| | | | 5.0 | 4.0 | ● | ● | ● | | | | | | | | |
| | | | 6.0 | 5.0 | ● | ● | ● | | | | | | | | |
| | | | 6.0 | 5.0 | ● | ● | ● | | | | | | | | |
| Custom healing abutment | | | | | | | ● | ● | ● | ● | ● | ● | ● | | |
| Splint healing cap | | | | | | | | | | ● | | | | | |
| | | | | | | | | In case a healing abutment with a height of 3–6 mm is used, the gingiva may be cut open at the time of attachment. | In case a healing abutment with a height of 3–6 mm is used, the gingiva may be cut open at the time of attachment. | A splint abutment is used in combination with a splint healing cap during secondary surgery. | A custom healing abutment should be attached to a ball abutment. | The emergence angles of transfer coping S and transfer coping L are the same as those of healing abutments with heights of 4.0 and 6.0 mm, respectively. | The emergence angle of the impression post is the same as that of a healing abutment with a height of 6.0 mm. | | |

Selection of a healing abutment

The number within the product name of the healing abutment indicates the height (H).
 Select the appropriate height of the healing abutment depending on the case.

Reference
 Example of product name
 FBL-HEAL AB-3.0-RP
 Height (H)



List of healing abutments for RP

| Product name | FBL-HEAL AB-2.0-RP | FBL-HEAL AB-3.0-RP | FBL-HEAL AB-4.0-RP | FBL-HEAL AB-5.0-RP | FBL-HEAL AB-6.0-RP |
|------------------|---|---|---|---|---|
| Schematic view |  |  |  |  |  |
| Height (H) | 2.0mm | 3.0mm | 4.0mm | 5.0mm | 6.0mm |
| Cuff height (GH) | 1.0mm | 2.0mm | 3.0mm | 4.0mm | 5.0mm |

Procedure for attaching the healing abutment

- Attach the healing abutment to the implant body using a hexalobular driver SH (for manual operation).
Before attaching the healing abutment, thoroughly clean the inside of the implant body to remove foreign material such as blood.

Reference

Use a hexalobular driver SH (for manual operation) to manually tighten the abutment.

Notes

Ensure that the tip of the driver is securely inserted in the cover screw and healing abutment before carrying it into the oral cavity.

- Close and suture the incisions in the alveolar mucosa around the healing abutment.

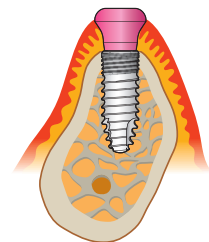
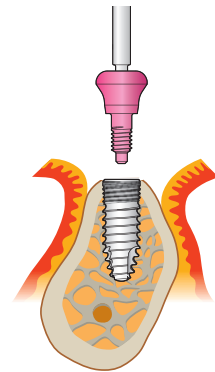

2 Custom healing abutment

- ◆ Intended use
 - Customized gingival management
- ◆ Material
 - Titanium alloy (Ti-6Al-4V ELI)
- ◆ Selection criteria
 - Formation of the emergence profile
- ◆ Tightening method
 - Manual (manual tightening)
- ◆ Indicated driver
 - Hexalobular driver SH
- ◆ Sterilization condition
 - Non-sterilized

Custom healing abutment



*Before attaching Non-sterilized products to implant bodies in the oral cavity, please sterilize them.

Variations in the custom healing abutment size (Unit: mm)

| Product drawing | Platform | Diameter of compatible implant (ϕ) | Diameter (W) |
|-----------------|----------|---|--------------|
| | NP | 3.2/3.4 | 3.9 |
| | RP | 3.7/4.2 | 4.1 |
| | WP | 4.7/5.2 | 5.2 |

Procedure for attaching the custom healing abutment

Blast the surface of the custom healing abutment and build up resin on it.

Attach the custom healing abutment to the implant body using a hexalobular driver SH (for manual operation).

Before attaching the custom healing abutment, thoroughly clean the inside of the implant body to remove foreign material such as blood. Then, close and suture the incisions in the alveolar mucosa around the custom healing abutment.

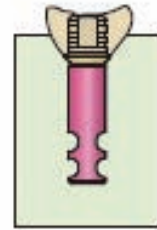

Reference

Use a hexalobular driver SH (for manual operation) to manually tighten the abutment.

Notes

Please sterilize the abutment before use.

Ensure that the tip of the driver is securely inserted in the screw before carrying it into the oral cavity.

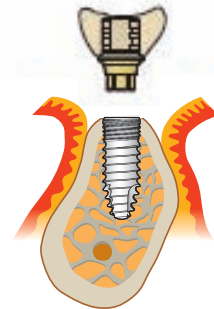

4. Impression taking

1 Impression techniques

The purpose of recording an impression for dental implant treatment is to precisely replicate the position of the implant body and abutment and the condition of surrounding tissues in the oral cavity on a work model.

For BL implants, the following three impression techniques can be used.

Select a technique suitable for the case and the indicated superstructure part.

(1) Direct impression

In the direct impression technique, a readymade abutment is attached to the implant body, and a direct impression of the readymade abutment is recorded using the same technique used for conventional crown restorations. This technique is used for cases where a readymade post is used and the margin is above the gingival margin. Using this technique, a superstructure can be manufactured with a normal removable model.

(2) Open tray impression

In the open tray impression technique, an open tray impression coping (transfer coping) is attached and a pick-up impression is recorded.

Thus, the body of the transfer copying is incorporated within the impression. This provides a more accurate impression.

This technique can be used for cases where the margin of the abutment is below the gingival margin and is very effective for long-span prostheses with custom abutments or screw-retained superstructures.

(3) Closed tray impression

In the closed tray impression technique, a closed tray impression coping (impression post) is attached and an impression is recorded using the same technique used for conventional crown restorations.

This technique can be used for cases where the margin of the abutment is below the gingival margin. With this technique, superstructures such as custom abutments or screw-retained superstructures can be manufactured.

Comparison of impression-taking techniques

| Direct impression | Open tray impression | Closed tray impression |
|---|--|--|
| <ul style="list-style-type: none"> ● Simple ● It is slightly inferior to other impression techniques with regard to the accuracy of the impression. | <ul style="list-style-type: none"> ● A little complicated ● Recording of a pick-up impression results in high impression accuracy. ● In the cases where multiple implant bodies are inserted, this technique provides greater impression accuracy compared with the closed tray impression technique. | <ul style="list-style-type: none"> ● Simple ● It is slightly inferior to the open tray impression technique with regard to the accuracy of the impression. |

2 Impression level

In dental implant treatment, an impression is recorded of the implant body or the abutment coupled with the implant body. The former is called an implant-level impression and the latter is called an abutment-level impression. The impression level should be selected on the basis of the prosthetic method and design.

Implant level

- When a custom abutment is manufactured
- When a superstructure is directly coupled with an implant body

Abutment level

- When a readymade abutment is coupled with an implant body for fabrication of the superstructure

Comparison of impression techniques and applicable superstructure parts

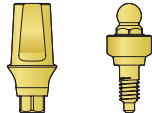
| | | | Direct impression (Abutment level) | |
|----------------------|-----------------|--|---------------------------------------|--|
| Impression parts | | | — | Applicable abutments  |
| Pro-sthesis | Cement-retained | | ○ | |
| Multiple impressions | | | (unsuitable for inclination) | |

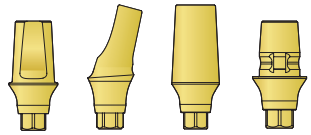
| | | | | Indirect impression (Implant level) | | |
|----------------------|-----------------|------------------------------|-----------------|--|--|--|
| Impression technique | | Closed tray | Open tray | Applicable abutments | | |
| Impression parts | | Impression post | Transfer coping |  | | |
| Pro-sthesis | Cement-retained | ○ | ○ | | | |
| | Screw-retained | ○ | ○ | | | |
| Multiple impressions | | (unsuitable for inclination) | ○ | | | |

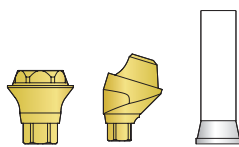
| | | | | Indirect impression (Implant level) | | |
|----------------------|----------------|---------------------------------------|---------------------------------------|--|--|--|
| Impression technique | | Closed tray | Open tray | Applicable abutments | | |
| Impression parts | | Impression post for a splint abutment | Transfer coping for a splint abutment |  | | |
| Pro-sthesis | Screw-retained | ○ | ○ | | | |
| Multiple impressions | | (unsuitable for inclination) | ○ | | | |

3 Direct impression

Step 1 Impression taking

Seal the screw access hole on the abutment to prevent the entry of impression material into the hole.
 Remove excess sealant so that it does not squeeze out from the access hole.
 Record the impression with silicon impression material using the conventional technique.

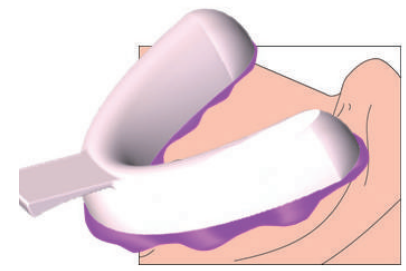

Reference
 If the margin of the abutment is below the gingival margin, the impression should be recorded using the indirect impression technique (closed tray/open tray impression technique).

Step 2 Manufacturing model

Pour plaster in the recorded impression using the conventional technique.

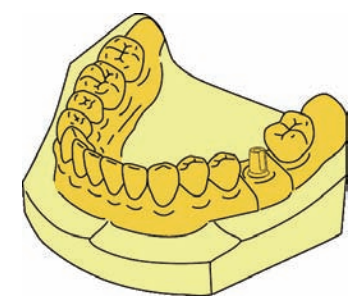

4 Open tray impression technique (implant level)

- ◆ Intended use
 - Impression taking using the open tray technique
- ◆ Material
 - Titanium alloy (Ti-6Al-4V ELI)
- ◆ Features
 - An accurate impression is obtained because the impression parts are picked up within the impression.
 - This technique can be used for a single prosthesis as well as a bridge.
 - The positional relationship of implant bodies is replicated in the recorded impression.
- ◆ Tightening method
 - Manual (manual tightening)
- ◆ Indicated driver
 - Hexalobular driver SH
- ◆ Sterilization condition
 - Non-sterilized

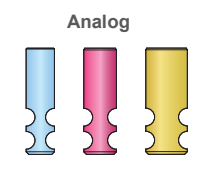
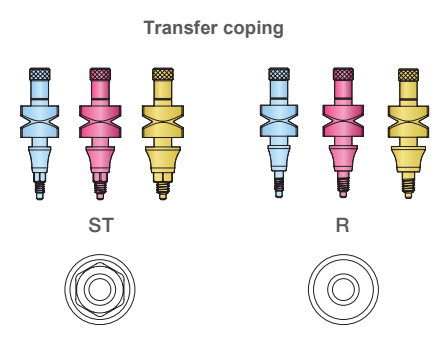

*Before attaching Non-sterilized products to implant bodies in the oral cavity, please sterilize them.

Variations in the transfer coping size

(Unit: mm)

| Product drawing | Platform | Size | Screw | Diameter of compatible implant (φ) | Height (H) |
|---|----------|------|-------|------------------------------------|------------|
|  ST R | NP | S | SS | 3.2/3.4 | 16.0 |
| | | | SL | | 21.0 |
| | | L | LS | | 22.0 |
| | | | LL | | 27.0 |
| | RP | S | SS | 3.7/4.2 | 16.0 |
| | | | SL | | 21.0 |
| | | L | LS | | 22.0 |
| | | | LL | | 27.0 |
| | WP | S | SS | 4.7/5.2 | 16.0 |
| | | | SL | | 21.0 |
| | | L | LS | | 22.0 |
| | | | LL | | 27.0 |

Variations in the analog size

(Unit: mm)

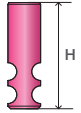
| Product drawing | Platform | Length (H) |
|---|----------|------------|
|  | NP | 12.0 |
| | RP | 12.0 |
| | WP | 12.0 |

*Light blue for NP (implant with a diameter (φ) of 3.2/3.4 mm)

*Pink for RP (implant with a diameter (φ) of 3.7/4.2 mm)

*Gold for WP (implant with a diameter (φ) of 4.7/5.2 mm)

Open tray impression technique (implant level)

Step 1 Transfer coping placement

- Before placing the transfer coping in the implant body, thoroughly clean the inside of the implant body.
- Securely attach the transfer coping to the implant body and tighten the positioning screw using a hexalobular driver SH.

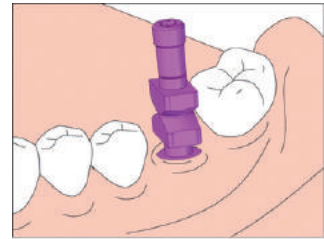

Technical points

For single-tooth impressions, use transfer coping ST (with antirotation mechanism), and for multiple-tooth impressions, use transfer coping R (without antirotation mechanism).

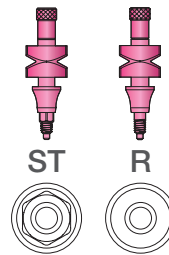

Step 2 Impression taking

- Record an impression with a silicon impression material.

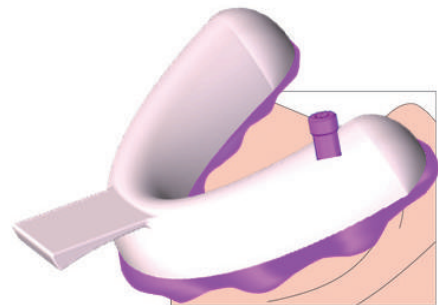

Once the impression material sets, loosen the screw and remove the impression tray from the oral cavity.



Step 3 Fabricate a work model

- Connect an analog to the transfer coping picked up within the impression. Ensure that the analog is securely connected to the transfer coping. Tighten the screw. Hold the analog in the hand while tightening the screw.
- Pour plaster in the recorded impression using the conventional technique.

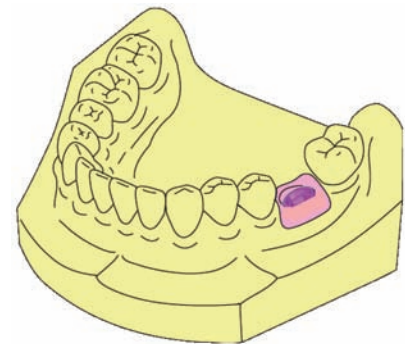

5 Closed tray impression technique (implant level)

◆ Intended use

- Impression taking using the closed tray technique

◆ Material

- Impression post: titanium alloy (Ti-6Al-4V ELI)
- Impression cap: polypropylene (PP)

◆ Features

- An accurate impression is obtained because the impression cap is picked up within the impression.
- This technique can be used for a single tooth.
- The positional relationship of implant bodies is replicated in the recorded impression.

◆ Tightening method

- Manual (manual tightening)

◆ Indicated driver

- Hexalobular driver SH

◆ Sterilization condition

- Non-sterilized

* Before attaching Non-sterilized products to implant bodies in the oral cavity, please sterilize them.

Impression post

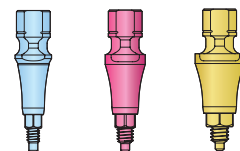

Impression cap



Analog

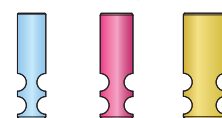

Variations in the impression post size

(Unit: mm)

| Product drawing | Platform | Size | Diameter of compatible implant (φ) | Height (H) |
|---|----------|------|------------------------------------|------------|
|  | NP | S | 3.2/3.4 | 11.1 |
| | | L | | 14.1 |
| | RP | S | 3.7/4.2 | 11.1 |
| | | L | | 14.1 |
| | WP | S | 4.7/5.2 | 11.1 |
| | | L | | 14.1 |

Variations in the analog size

(Unit: mm)

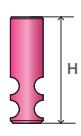
| Product drawing | Platform | Length (H) |
|---|----------|------------|
|  | NP | 12.0 |
| | RP | 12.0 |
| | WP | 12.0 |

*Light blue for NP (implant with a diameter (φ) of 3.2/3.4 mm)

*Pink for RP (implant with a diameter (φ) of 3.7/4.2 mm)

*Gold for WP (implant with a diameter (φ) of 4.7/5.2 mm)

Information

Impression cap

- The impression cap is equipped with antirotation and anti-displacement mechanisms, which facilitates the acquisition of a pick-up impression replicating the accurate positional relationship.
- The polypropylene (PP) impression cap is common for all sizes of BL and TL implants.
- When the impression cap is used, a margin of 0.3 mm from the impression post is required.

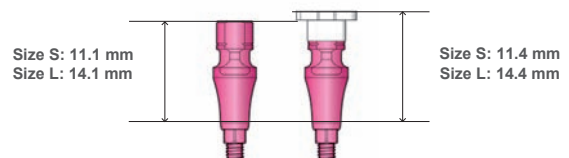

Closed tray impression technique (implant level)

Step 1 Impression post placement

- Before placing an impression post in the implant body, thoroughly clean the inside of the implant body.
- Securely attach the impression post to the implant body and tighten the positioning screw using a hexalobular driver SH.

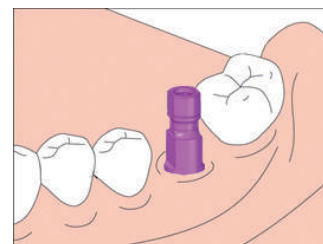

- Accurately attach an impression cap to the impression post.

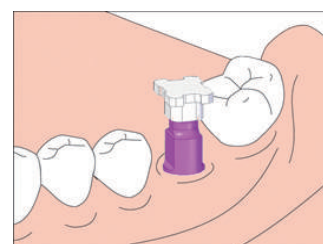

Notes

- Do not reuse the impression cap.
- Ensure that the head of the impression post is hidden by the cap.



Step 2 Impression taking

- Record an impression with a silicon impression material.

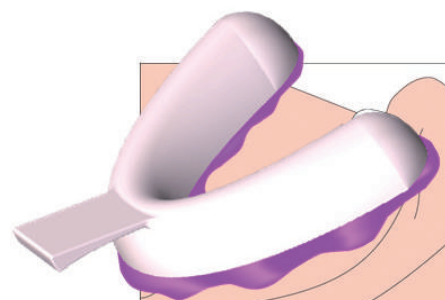

- Once the impression material sets, remove the impression tray from the oral cavity. The impression cap is picked up on the surface of the impression.

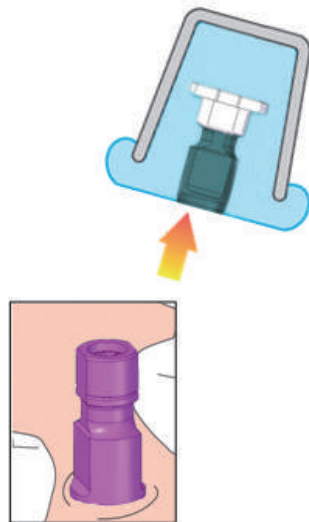

Step 3 Fabricate a work model

- Replace the impression post coupled with an analog in the impression cap picked up within the impression. Pour plaster in the recorded impression using the conventional technique.

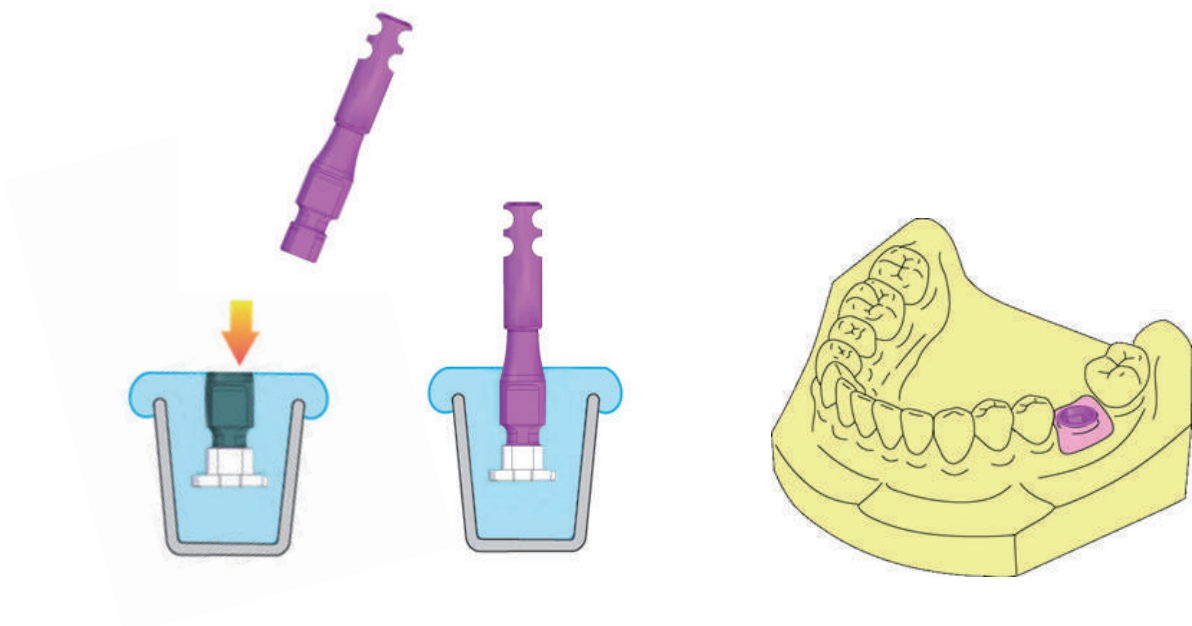

6 Open tray impression technique (abutment level)

◆ Intended use

- Impression taking using the open tray technique

◆ Material

- Transfer coping for a splint abutment: stainless steel
- Analog for a splint abutment: titanium alloy (Ti-6Al-4V ELI)

◆ Features

- An accurate impression is obtained because the impression parts are picked up within the impression.
- This technique can be used for a single prosthesis as well as a bridge.
- The positional relationship of the splint abutment is replicated in the recorded impression.

◆ Tightening method

- Manual (manual tightening)

◆ Indicated driver

- Hexalobular driver SH

◆ Sterilization condition

- Non-sterilized

*Before attaching Non-sterilized products to implant bodies in the oral cavity, please sterilize them.

Transfer coping for a splint abutment

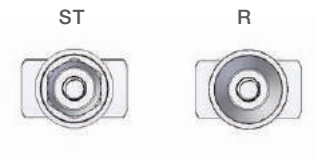
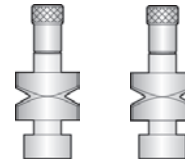

Analog for a splint abutment



*To fabricate a superstructure replacing several teeth, split the framework into pieces and check the fitness through a try-in in the oral cavity. Consider fixing the pieces of the framework for the try-in and subsequently couple them by waxing.

Variations in the size of the transfer coping for a splint abutment (Unit: mm)

| Product drawing | Size | Screw | Diameter of compatible implant (φ) | Height (H) |
|---|------|-------|------------------------------------|------------|
|  <p>ST R</p> | S | SS | 3.7/4.2 4.7/5.2 | 16.0 |
| | | SL | | 21.0 |
| | L | LS | | 20.0 |
| | | LL | | 25.0 |

Variations in the size of the analog for a splint abutment

(Unit: mm)

| Product drawing | Length (H) |
|---|------------|
|  | 14.0 |

Open tray impression technique (abutment level)

Step 1 Placement of the transfer coping for a splint abutment

- Before placing a transfer coping for a splint abutment in the implant body, thoroughly clean the inside of the implant body.
- Securely attach the transfer coping to the implant and tighten the screw using a hexalobular driver SH.

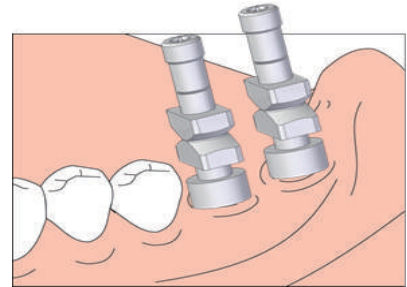

Technical points

- For a single-tooth impression, use transfer coping ST (with antirotation mechanism).
- For a multiple-tooth impression, use transfer coping R (without antirotation mechanism).

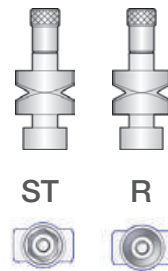

- If required for a bridge, couple the transfer copings.
To minimize changes due to polymerization shrinkage of resin, follow these steps to couple the transfer copings.

- 1) Couple the transfer copings using a resin with less polymerization shrinkage.
- 2) To minimize distortion due to polymerization shrinkage, cut the resin coupling using a thin disk.
- 3) Recouple the copings using a pattern resin.

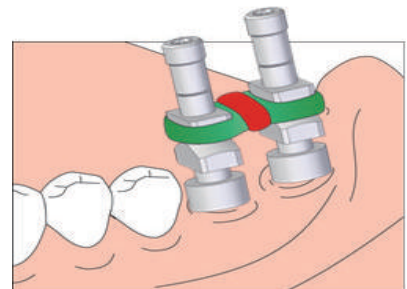

Step 2 Impression taking

- Record an impression with a silicon impression material.

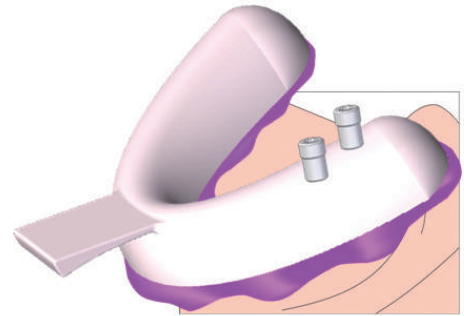

- Once the impression material sets, loosen the screw and remove the impression tray from the oral cavity.

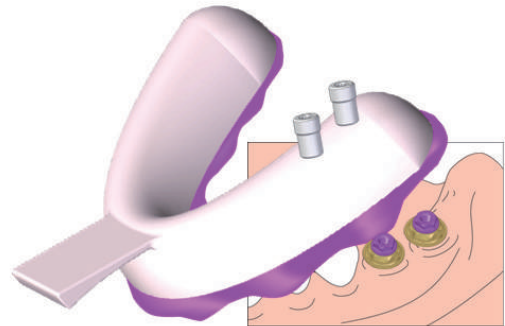

Step 3 Fabricate a work model

- Connect the analog to the transfer coping for a splint abutment picked up within the impression. Ensure that the analog is securely connected to the transfer coping. Tighten the screw. Hold the analog in the hand while tightening the screw. Pour plaster in the recorded impression using the conventional technique.

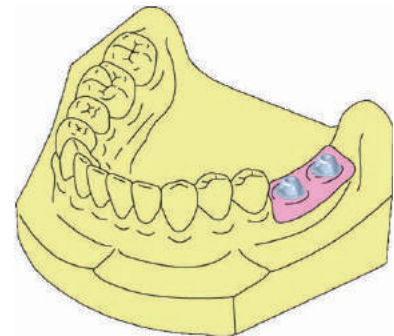

7 Closed tray impression technique (abutment level)

◆ Intended use

- Impression taking using the closed tray technique

◆ Material

- Impression post for a splint abutment: stainless steel
- Analog for a splint abutment: titanium alloy (Ti-6Al-4V ELI)

◆ Features

- This technique can be used for a single prosthesis as well as a bridge.
- The positional relationship of the splint abutment is replicated in the recorded impression.

◆ Tightening method

- Manual (manual tightening)

◆ Indicated driver

- Impression driver

◆ Sterilization condition

- Non-sterilized

* Before attaching Non-sterilized products to implant bodies in the oral cavity, please sterilize them.

* To fabricate a superstructure replacing several teeth, split the framework into pieces and check the fitness through a try-in in the oral cavity.
Consider fixing the pieces of the framework for the try-in and subsequently couple them by waxing.

Impression post for a splint abutment

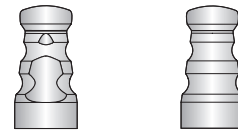

ST

R



Analog for a splint abutment



Variations in the size of the impression post for a splint abutment

(Unit: mm)

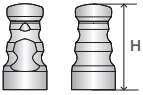
| Product drawing | Length (H) |
|--|------------|
|  ST R | 9.4 |

Variations in the size of the analog for a splint abutment

(Unit: mm)

| Product drawing | Length (H) |
|---|------------|
|  | 14.0 |

Closed tray impression technique (abutment level)

Step 1 Placement of the impression post for a splint abutment

- Securely attach the impression post to the splint abutment and tighten using an impression driver.

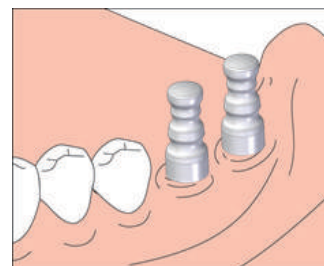

- Once the impression material sets, remove the impression tray from the oral cavity.

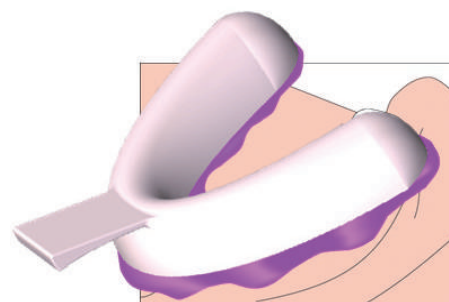

Step 2 Fabricate a work model

- Connect an analog for a splint abutment to the impression post.



Step 3 Fabricate a work model

- Couple the analog to the impression post and replace it on the impression surface. Pour plaster in the recorded impression to fabricate a model.

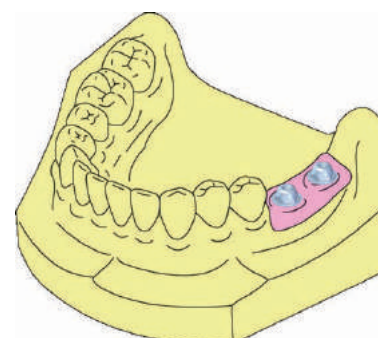

8 Digital impression technique

- ◆ Intended use
 - Impression taking using the digital technique (scan body)
- ◆ Material
 - PEEK
- ◆ Tightening method
 - Manual (manual tightening)
- ◆ Indicated driver
 - Scan body: hexalobular driver SH
 - Scan body for a splint abutment: flex driver CH + CH adapter
- ◆ Sterilization condition
 - Non-sterilized

Scan body



Scan body for a splint abutment

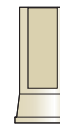

*Before attaching Non-sterilized products to implant bodies in the oral cavity, please sterilize them.

Digital impression technique

The combination of the FINESIA BL implant system with a scan body allows for the recording of a digital impression using an intraoral scanner and a desktop scanner. The acquired data enables the dental laboratory (in-hospital laboratory) to fabricate prostheses using CAD/CAM techniques.

Flow diagram for the digital impression technique

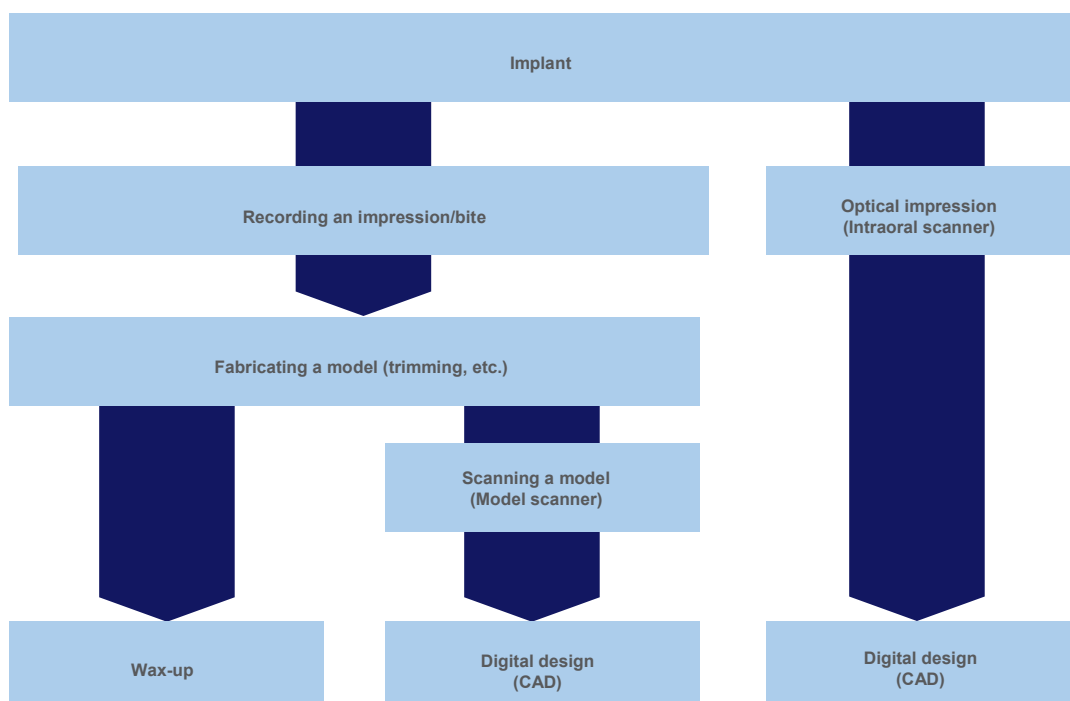

Variations in the scan body size (Unit: mm)

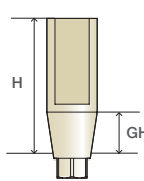
| Product drawing | Size | Diameter of compatible implant | Height (H) | Cuff height (GH) |
|---|------|--------------------------------|------------|------------------|
|  | NP | 3.2/3.4 | 10.0 | 2.9 |
| | RP | 3.7/4.2 | | |
| | WP | 4.7/5.2 | | |

Variations in the size of the scan body for a splint abutment

(Unit: mm)

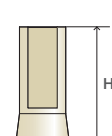
| Product drawing | Diameter of compatible implant | Height (H) |
|---|--------------------------------|------------|
|  | 3.7/4.2 4.7/5.2 | 10.0 |

Digital impression technique

Intraoral digital impression technique

Attach a scan body and tighten using an abutment screw.



- * Use an abutment screw for the scan body. For the scan body for a splint abutment, use a cylinder screw.

Digital impression technique using a model

Attach an impression coping to the implant body to record an impression.



Fabricate an analog model.



Attach a scan body to the analog model and tighten using a lab screw.



- * For a scan body to be used with a model, use a lab screw. For the scan body for a splint abutment to be used with a model, use a lab screw for a splint abutment.

Notes

- Ensure that the abutment screw, cylinder screw, and scan body are sterilized before use.
- Do not reuse the abutment screw or cylinder screw.

Technical points

While recording an impression, attach the scan body in such a manner that the dimple (plane) set on the scan body is on the buccal side or labial or lingual surface.

Record a digital impression using an intraoral scanner.



After obtaining the digital impression data, check for impression accuracy. Then, send the data to a dental laboratory or in-hospital laboratory.



* For information on dental laboratories that use CAD/CAM systems for the FINESIA BL implant system, contact us.

5. Provisional restoration

1 Temporary abutment

- ◆ Intended use
 - Fabrication of provisional crowns for cement-retained or screw-retained superstructures
 - Fabrication of provisional bridges for cement-retained or screw-retained superstructures
- ◆ Material
 - Titanium alloy (Ti-6Al-4V ELI)
- ◆ Features
 - Can be used for manufacturing a provisional restoration
 - Can be customized by grinding and resin build-up
- ◆ Application
 - Formation of the emergence profile
- ◆ Tightening torque
 - NP 20 N·cm
 - RP 30 N·cm
 - WP 30 N·cm
- ◆ Indicated driver
 - Hexalobular driver
- ◆ Sterilization condition
 - Non-sterilized

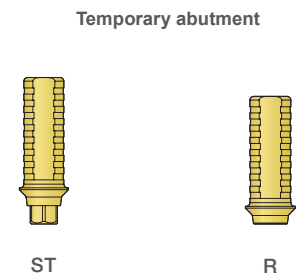

*Before attaching Non-sterilized products to implant bodies in the oral cavity, please sterilize them.

Basic technique for temporary abutments

Primary/secondary operation

- Implant placement
- Attachment of cover screw or healing abutment

Tightening method

Manual (manual tightening)

Indicated driver

Hexalobular driver SH

Provisional prosthesis

- Provisional restoration (attachment of temporary abutment)

Tightening torque

NP 20 N·cm

RP/WP 30 N·cm

Indicated driver

Hexalobular driver

Variations in temporary abutment size

(Unit: mm)

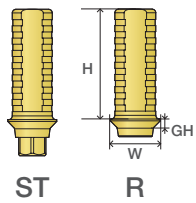
| Product drawing | Platform | Diameter of the compatible implant (Φ) | Diameter (W) | Post height (H) | Cuff height (GH) |
|---|----------|--|--------------|-----------------|------------------|
|  | NP | 3.2/3.4 | 3.9 | 9.0 | 0.9 |
| | | | 3.5 | | 2.0 |
| | | | | | 3.0 |
| | | | | | 4.0 |
| | | | | | 5.0 |
| | RP | 3.7/4.2 | 4.1 | 9.0 | 0.7 |
| | | | 4.5 | | 2.0 |
| | | | | | 3.0 |
| | | | | | 4.0 |
| | | | | | 5.0 |
| | WP | 4.7/5.2 | 5.2 | 9.0 | 0.7 |
| | | | 5.5 | | 2.0 |
| 3.0 | | | | | |
| 4.0 | | | | | |
| 5.0 | | | | | |

1-1 Precautions for the use of temporary abutments

- 1) As a standard, an abutment is installed at least 3 months after implant placement in the mandible and at least 6 months after implant placement in the maxilla. Before abutment placement, please ensure that the soft tissues and bone have healed.
- 2) This product is not sterilized.
- 3) Obtain X-ray images as needed and confirm that there is no gap between the abutment and implant body.
- 4) Before attaching the abutment, thoroughly clean the inside of the implant body and eliminate foreign material, including blood.
- 5) A lab screw is used for laboratory work. Because the shape of a lab screw is the same as that of an abutment screw, carefully check the product label before use to avoid confusion.
- 6) The tightening torque for a tightened screw is slightly decreased because of initial plastic deformation of the screw itself. Retightening restores the fastening force, brings the components closer, and prevents loosening. Retighten the abutment screw two or three times.
- 7) Use an alternatively available abutment screw at the time of replacement during maintenance.
- 8) Do not store the products in an area exposed to high temperature, humidity, or direct sunlight. To prevent the risk of infection, never use implant bodies dropped on the floor or contaminated by foreign material such as saliva. Please discard such implants.
- 9) When tightening the abutment or operating a dedicated tool, be careful so that the patient does not accidentally swallow them.
- 10) Do not subject the abutment to excessive force, which can deform or damage it.
- 11) Check the package before opening it. Do not use the abutment, if the package is damaged.
- 12) Do not use any tool other than dedicated ones, otherwise you can damage the implant body.
- 13) Assume that the maximum usable time for temporary abutments is 2 months.
- 14) No occlusal force should be applied to the temporary abutment, considering it is a temporary component.
- 15) Read the package inserts before use and thoroughly understand the function, method of use, and surgical procedure.

Fabrication of a provisional restoration using a temporary abutment

Step 1 Adjustment of the temporary abutment

- Attach the temporary abutment on an analog and tighten the lab screw using a hexalobular driver.

Technical points

For a single tooth, use temporary abutment ST (with antirotation mechanism), and for a bridge, use temporary abutment R (without antirotation mechanism).

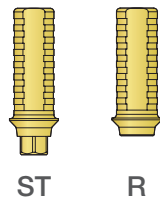

- With reference to the height of the adjacent teeth and clearance of the opposing tooth, mark the post of the temporary abutment at an appropriate height and adjust the post by grinding as required.

Notes

The abutment screw head is set 2.5 mm from the platform of the BL fixture.
Adjust the height of the post so that the screw head does not protrude.

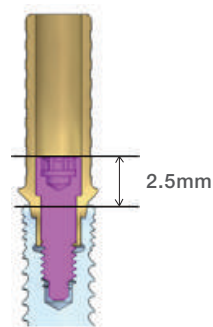

Step 2 Adjustment with gum silicon

- Taking the anatomical form into consideration, create an emergence profile by grinding gum silicon as required.



Step 3 Wax-up

- Fabricate a wax-up keeping in mind the anatomical form.



Step 4 Building up resin

- Build up resin on the temporary abutment.
Sandblast the surface of the titanium abutment before building up resin.
Prevent the sandblaster from coming in contact with the fit. Otherwise, the fit will be compromised.



- Correct the form of the provisional resin restoration.



6. Cement-retained superstructure

1 Post abutment

- ◆ Intended use
 - Fabrication of cement-retained superstructures (single tooth or multiple teeth)
- ◆ Material
 - Titanium alloy (Ti-6Al-4V ELI)
- ◆ Tightening torque
 - NP 20 N·cm
 - RP 30 N·cm
 - WP 30 N·cm
- ◆ Indicated driver
 - Hexalobular driver
- ◆ Sterilization condition
 - Non-sterilized

*Before attaching Non-sterilized products to implant bodies in the oral cavity, please sterilize them.

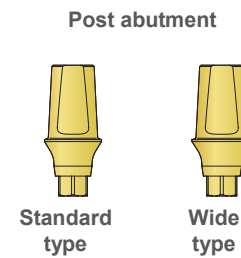

Basic technique for post abutments

Primary/secondary operation

- Implant placement
- Attachment of cover screw or healing abutment

Tightening method

Manual (manual tightening)

Indicated driver

Hexalobular driver SH

Provisional/final prosthesis

- Attachment of abutment/final prosthesis

Tightening torque

NP 20 N·cm

RP/WP 30 N·cm

Indicated driver

Hexalobular driver

Variations in the post abutment size (standard) (Unit: mm)

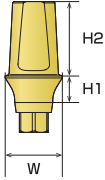
| Product drawing | Platform | Diameter of compatible implant (ϕ) | Cuff height (H1) | Diameter (W) | Post length (H2) | |
|---|----------|---|------------------|--------------|------------------|-----|
| | | | | | S | M |
|  | NP | 3.2/3.4 | 1.0 | 3.5 | 4.1 | 5.6 |
| | | | 2.0 | | | |
| | | | 3.0 | | | |
| | | | 4.0 | | | |
| | | | 5.0 | | | |
| | RP | 3.7/4.2 | 1.0 | 4.5 | | |
| | | | 2.0 | | | |
| | | | 3.0 | | | |
| | | | 4.0 | | | |
| | | | 5.0 | | | |
| | WP | 4.7/5.2 | 1.0 | 5.5 | | |
| | | | 2.0 | | | |
| | | | 3.0 | | | |
| | | | 4.0 | | | |
| | | | 5.0 | | | |

Variations in the post abutment size (wide) (Unit: mm)

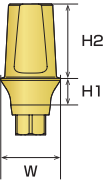
| Product drawing | Platform | Diameter of compatible implant (ϕ) | Cuff height (H1) | Diameter (W) | Post length (H2) |
|---|----------|---|------------------|--------------|------------------|
| | | | | | M |
|  | RP | 3.7/4.2 | 1.0 | 5.0 | 5.6 |
| | | | 2.0 | | |
| | | | 3.0 | | |
| | | | 4.0 | | |
| | | | 5.0 | | |
| | WP | 4.7/5.2 | 1.0 | 6.0 | |
| | | | 2.0 | | |
| | | | 3.0 | | |
| | | | 4.0 | | |
| | | | 5.0 | | |

6. Cement-retained superstructure

Fabrication of a superstructure using a post abutment

Step 1 Fabrication of a work model

- Fabricate a work model by recording a direct impression.



Step 2 Wax-up

- Create a wax-up with the final contour.



Step -3 Correction of form/polishing

- Correct the form of the cast superstructure and polish it.
Adequately polish the area that comes in contact with the gingiva.

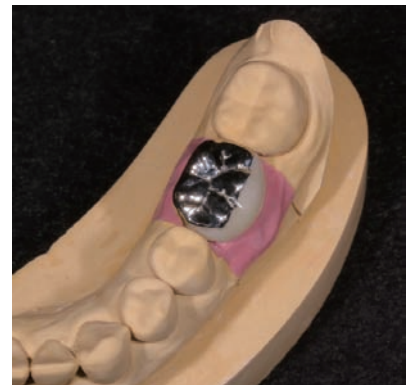

2 Angle abutment/prepable abutment

◆ Intended use

- Fabrication of cement-retained superstructures (single tooth or multiple teeth)
- Fabrication of a custom abutment by adjustment through grinding

◆ Material

- Titanium alloy (Ti-6Al-4V ELI)

◆ Tightening torque

- NP 20 N·cm
- RP 30 N·cm
- WP 30 N·cm

◆ Indicated driver

- Hexalobular driver

◆ Sterilization condition

- Non-sterilized

*Before attaching Non-sterilized products to implant bodies in the oral cavity, please sterilize them.

Angle abutment

Prepable abutment



An angle abutment is inclined toward the edge of the hexagon.

Basic technique for angle abutments/prepable abutments

Primary/secondary operation

- Implant placement
- Attachment of cover screw or healing abutment

Tightening method

Manual (manual tightening)

Indicated driver

Hexalobular driver SH

Provisional prosthesis

- Provisional restoration (attachment of temporary abutment)

Tightening torque

NP 20 N·cm

RP/WP 30 N·cm

Indicated driver

Hexalobular driver

Final prosthesis

- Attachment of abutment/final prosthesis

Tightening torque

NP 20 N·cm

RP/WP 30 N·cm

Indicated driver

Hexalobular driver

Variations in the angle abutment size

(Unit: mm)

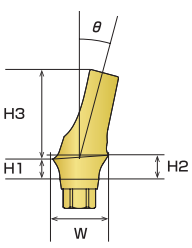
| Product drawing | Platform | Diameter of compatible implant (φ) | Cuff height | | Post length | Diameter (W) | | Angle (θ) |
|---|----------|------------------------------------|-------------|-----|-------------|--------------|------|-----------|
| | | | H1 | H2 | | Standard | Wide | |
|  | NP | 3.2/3.4 | 1.6 | 1.9 | 7.0 | 3.5 | 4.0 | 15° |
| | | | 2.6 | 2.9 | | | | |
| | | | 3.6 | 3.9 | | | | |
| | | | 4.6 | 4.9 | | | | |
| | RP | 3.7/4.2 | 1.6 | 1.9 | 7.0 | 4.5 | 5.0 | 15° |
| | | | 2.6 | 2.9 | | | | |
| | | | 3.6 | 3.9 | | | | |
| | | | 4.6 | 4.9 | | | | |
| | WP | 4.7/5.2 | 1.6 | 1.9 | 7.0 | 5.5 | 6.0 | 15° |
| | | | 2.6 | 2.9 | | | | |
| | | | 3.6 | 3.9 | | | | |
| | | | 4.6 | 4.9 | | | | |

Variations in the preable abutment size

(Unit: mm)

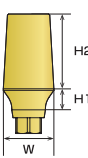
| Product drawing | Platform | Diameter of compatible implant (φ) | Cuff height | Post length | Diameter (W) | |
|---|----------|------------------------------------|-------------|-------------|--------------|----------|
| | | | H1 | | H2 | Standard |
|  | NP | 3.2/3.4 | 1.0 | 7.1 | 3.5 | 4.0 |
| | | | 2.0 | | | |
| | | | 3.0 | | | |
| | | | 4.0 | | | |
| | | | 5.0 | | | |
| | RP | 3.7/4.2 | 1.0 | 7.1 | 4.5 | 5.0 |
| | | | 2.0 | | | |
| | | | 3.0 | | | |
| | | | 4.0 | | | |
| | | | 5.0 | | | |
| | WP | 4.7/5.2 | 1.0 | 7.1 | 5.5 | 6.0 |
| | | | 2.0 | | | |
| 3.0 | | | | | | |
| 5.0 | | | | | | |

Fabrication of a superstructure using an angle abutment/a preable abutment

Step 1 Adjustment of the angle or preable abutment

- Attach the abutment indicated for an analog model.
An angle abutment/a preable abutment can be adjusted by grinding.
Mark the post so that you can check the direction of attachment while attaching and removing the abutment to/from the model.



Notes

An angle abutment is inclined toward the edge of the hexagon.



Notes

The angular orientation of the angle depends on the orientation of the hexagon on the abutment fitting area of the implant body.
⇒P.74

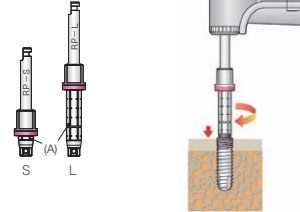

- Position the margin line.
- Adjust the margin and post to the required shapes.

Technical points

- The margin varies in shape depending on the type or material of the final prosthesis. Adjust the margin to a shape suitable for the final prosthesis.
- Set the taper angle of the post to an appropriate value for retention.
- Set the post height according to the contour and type of the final prosthesis.

Important

Portion of the angle abutment/preable abutment that should not be ground

Set the taper on the axial plane at 2–6° to the tooth axis.

- To finish the marginal area, use a bar with a radius of 0.2 mm or more at the tip.
- Do not grind the area up to 2.0 mm from the mating face of the abutment.
- Ensure a height of at least 4.6 mm from the lower end of the abutment so that the abutment screw does not protrude from the access hole during processing.
- Process the portion within a range of 0.5 mm below the level of the maximum outer diameter (toward the mating face) and ensure a diameter equal to or larger than the specified value for the margin portion. (See the below table.)

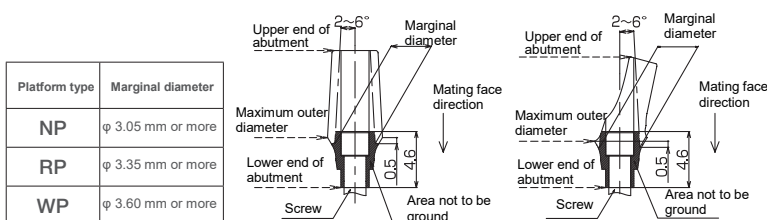

Step 2 Wax-up and casting

- Create a wax-up after considering the anatomical form and cut it back as needed. After spruing and investing according to the conventional technique, cast a frame using the conventional technique for crowns/bridges.

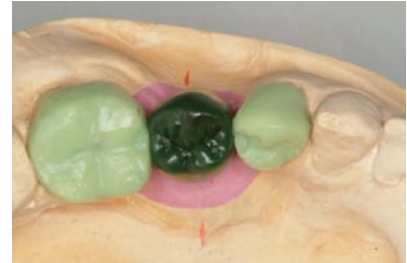
**Step 3 Form correction/polishing**

- According to the facing material to be used, adjust the metal frame and treat the surface.



- Build up the facing material on the metal frame, correct the form, and polish the surface according to the conventional technique.



- Burnish the surface.



3 Cast-on abutment

◆ Intended use

- Fabrication of cement-retained superstructures using custom abutments
- Fabrication of screw-retained superstructures (single tooth or multiple teeth)

◆ Material

- Gold alloy (Ceramicor, manufactured by CENDRES+METAUX)

◆ Criteria for selection

- Insertion of single-tooth implants
- Insertion of multiple-tooth implants
- Applicable even when the clearance of the opposing tooth is inadequate (for screw-retained superstructures)

◆ Tightening torque

- NP 20 N·cm
- RP 30 N·cm
- WP 30 N·cm

◆ Indicated driver

- Hexalobular driver

◆ Sterilization condition

- Unsterilized

* Make sure to sterilize an unsterilized component before attaching it to the implant body in the oral cavity.

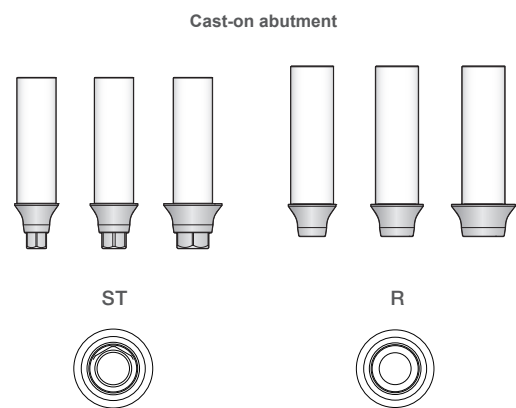

Basic surgical procedure for cast-on abutments

Primary surgery

- Implant placement.
- Attach cover screw or healing abutment.

Tightening method

Manual (manual tightening)

Indicated driver

Hexalobular driver SH



Temporary prosthesis

- Provisional restoration (attachment of temporary abutment)

Tightening torque

NP 20 N•cm

RP/WP 30 N•cm

Indicated driver

Hexalobular driver



Final prosthesis

- Attachment of abutment/final prosthesis

Tightening torque

NP 20 N•cm

RP/WP 30 N•cm

Indicated driver

Hexalobular driver

Variations in cast-on abutment size

(Unit: mm)

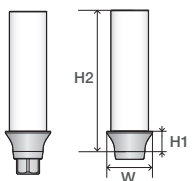
| Product drawing | Platform | Diameter of compatible implant (Φ) | Diameter (W) | Cuff height (H1) | Height (H2) |
|---|----------|---|--------------|------------------|-------------|
|  | NP | 3.2/3.4 | 4.1 | 2 | 14 |
| | RP | 3.7/4.2 | 4.5 | | |
| | WP | 4.7/5.2 | 5.5 | | |

3-1 Precautions for the use of cast-on abutments

- 1) As a standard, an abutment is installed at least 3 months after implant placement in the mandible and at least 6 months after implant placement in the maxilla. Before abutment placement, please ensure that the soft tissues and bone have healed.
- 2) This product is not sterilized.
- 3) Obtain X-ray images as needed and confirm that there is no gap between the abutment and implant body.
- 4) Before attaching the abutment, thoroughly clean the inside of the implant body and eliminate foreign material, including blood.
- 5) A lab screw is used for laboratory work. Because the shape of a lab screw is the same as that of an abutment screw, carefully check the product label before use to avoid confusion.
- 6) The tightening torque for a tightened screw is slightly decreased because of initial plastic deformation of the screw itself. Retightening restores the fastening force, brings the components closer, and prevents loosening. Retighten the abutment screw two or three times.
- 7) Use an alternatively available abutment screw at the time of replacement during maintenance.
- 8) Do not store the products in an area exposed to high temperature, humidity, or direct sunlight. To prevent the risk of infection, never use implant bodies dropped on the floor or contaminated by foreign material such as saliva. Please discard such implants.
- 9) When tightening the abutment or operating a dedicated tool, be careful so that the patient does not accidentally swallow them.
- 10) Do not subject the abutment to excessive force, which can deform or damage it.
- 11) Check the package before opening it. Do not use the abutment, if the package is damaged.
- 12) Do not use any tool other than dedicated ones, otherwise you can damage the implant body.
- 13) Please read the package inserts before use and thoroughly understand the function, method of use, and surgical procedure.

3-2 Fabrication of a cement-retained superstructure using a cast-on abutment (custom abutment)

Step 1 Adjustment of the cast-on abutment

- Attach the cast-on abutment to an analog model.

Technical points

For a single tooth, use cast-on abutment ST (with an antirotation mechanism).



- With reference to the height of the adjacent teeth and clearance of the opposing tooth, perform milling to adjust the post as necessary.

Notes

Adjust the height while taking care not to grind the gold alloy portion.

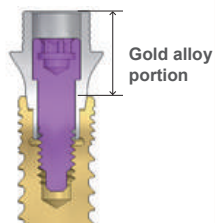

Step 2 Wax-up

- Considering the anatomic form, fabricate a wax-up of the final post form on the cast-on abutment.

**Step 3 Spruing/investing/casting**

- Following spruing and investment of the waxed-up superstructure, perform the casting procedure using the conventional technique.

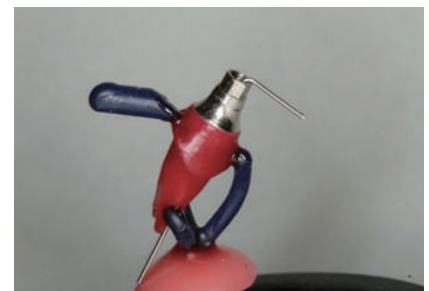

6. Cement-retained superstructure

Step 4 Correction of form/polishing

- Correct the form of the cast superstructure and polish it.
In particular, take care while polishing the portion that comes in contact with the gingiva.



- Check the relationship with the gingiva, perform the necessary adjustments, and create the framework for the final prosthesis.



- Build up facing material, correct the form, and polish the surface. The procedure is now complete.



7. Screw-retained superstructure

1 Splint abutment

◆ Intended use

- Fabrication of screw-retained superstructures (single tooth or multiple teeth)
- Fabrication of overdentures

◆ Material

- Splint abutment Titanium alloy (Ti-6Al-4V ELI)
- Splint healing cap Titanium alloy (Ti-6Al-4V ELI)
- Temporary cylinder Titanium alloy (Ti-6Al-4V ELI)
- Gold cylinder Gold alloy (Ceramicor: manufactured by Cendres+Métaux)



◆ Selection criteria

- Insertion of single-tooth implants
- Insertion of multiple-tooth implants

*Splint abutments are recommended for the insertion of multiple-tooth implants.

◆ Tightening torque/method

- Splint abutment (straight) 30 N·cm
- Splint abutment (angle) 20 N·cm
- Gold cylinder/temporary cylinder 20 N·cm
- Splint healing cap Manual (manual tightening)

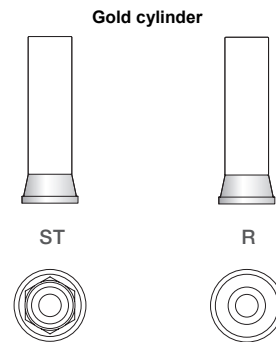

◆ Indicated driver

- Splint abutment (straight) Driver for splint abutment
- Splint abutment (angle) Flex driver CH
- Splint healing cap Flex driver CH + CH adapter
- Temporary cylinder Flex driver CH
- Gold cylinder Flex driver CH

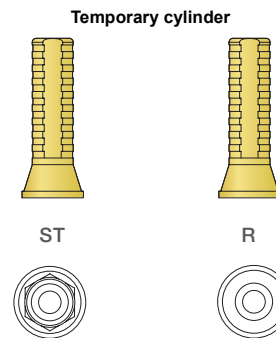

◆ Sterilization condition

- Splint abutment Sterilized
- Splint healing cap/gold cylinder/temporary cylinder Non-sterilized

*Before attaching Non-sterilized products to implant bodies in the oral cavity, please sterilize them.

Splint healing cap



Basic technique for splint abutments

Primary operation

- Implant placement
- Attachment of cover screw or healing abutment

Tightening method

Manual (manual tightening)

Indicated driver

Hexalobular driver SH

Basic technique for splint abutments (secondary operation)

- Attachment of splint abutments

Tightening torque

Straight 30 N·cm

Angle 20 N·cm

Indicated driver

Straight-type

Driver for splint abutment

Angle-type

Flex driver CH

Provisional prosthesis

- Provisional restoration (temporary cylinder attachment)

Tightening torque

20 N·cm

Indicated driver

Flex driver CH

Final prosthesis

- Final prosthesis attachment

Tightening torque

20 N·cm

Indicated driver

Flex driver CH

Variations in the splint abutment size

● Straight-type

(Unit: mm)

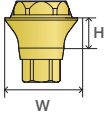
| Product drawing | Platform | Diameter of compatible implant (φ) | Cuff height (H) | Diameter (W) |
|---|----------|------------------------------------|-----------------|--------------|
|  | RP | 3.7/4.2 | 1.0 | 4.8 |
| | | | 2.0 | |
| | | | 3.0 | |
| | | | 4.0 | |
| | | | 5.0 | |
| | WP | 4.7/5.2 | 1.0 | |
| | | | 2.0 | |
| | | | 3.0 | |
| | | | 4.0 | |
| | | | 5.0 | |

● Angle-type

(Unit: mm)

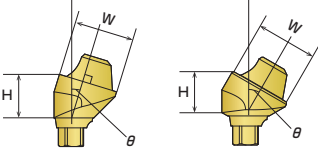
| Product drawing | Platform | Diameter of compatible implant (φ) | Cuff height (H) | Diameter (W) | Angle (θ) | |
|---|----------|------------------------------------|-----------------|--------------|-----------|-----|
|  <p>Angle 17° Angle 30°</p> | RP | 3.7/4.2 | 2.5 | 4.8 | 17° | |
| | | | 3.5 | | | |
| | | | 4.5 | | | |
| | | | 4.5 | | | |
| | WP | 4.7/5.2 | 3.5 | | 17° | |
| | | | 4.5 | | | |
| | | | 3.5 | | | 30° |
| | | | 4.5 | | | |

Variations in the temporary cylinder size

(Unit: mm)

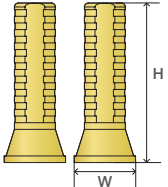
| Product drawing | Length (H) | Diameter (W) |
|--|------------|--------------|
|  <p>ST R</p> | 12.0 | 4.8 |

Variations in the gold cylinder size

(Unit: mm)

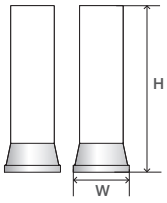
| Product drawing | Length (H) | Diameter (W) |
|--|------------|--------------|
|  <p>ST R</p> | 14.5 | 4.8 |

Variations in the splint healing cap size

(Unit: mm)

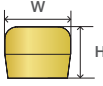
| Product drawing | Length (H) | Diameter (W) |
|---|------------|--------------|
|  | 4.3 | 5.3 |

Features of technique for splint abutments

Splint abutments are applied to screw-retained superstructures or overdentures with bar attachments.

Splint abutments can be classified into two types: straight and angle (17° and 30°). They are available with various neck sizes. You can select an appropriate splint abutment according to the soft tissue thickness for effective correction of the direction of implant body insertion.

Splint abutments are designed on the basis of the one-time one-abutment concept. Therefore, a sterilized abutment should be fastened during the secondary operation, following which the abutment attached to the implant body is attached to the final prosthesis. This procedure enables accurate prosthetic restoration with a screw-retained superstructure for multiple teeth, where a passive fit is required.

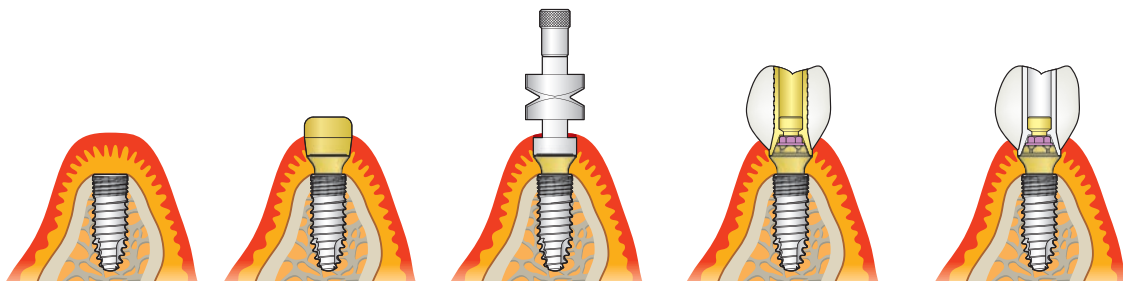

| Primary operation | Secondary operation | Impression taking | Provisional | Final prosthesis |
|-------------------|---------------------------------------|---|---------------------------------------|----------------------------------|
| Cover screw | Splint abutment Splint healing cap | Splint abutment Transfer coping for a splint abutment OR Impression post for a splint abutment | Splint abutment Temporary cylinder | Splint abutment Gold cylinder |

Splint abutment straight type mounting

- Lightly tighten the splint abutment straight type to the implant body using the pre-mounted abutment carrier.

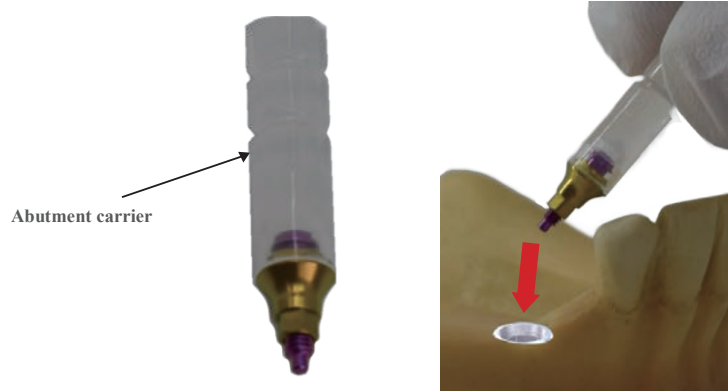

- After lightly tightening, remove the abutment carrier.

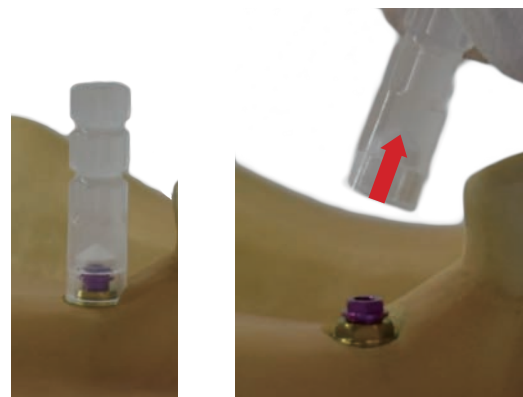

- Tighten the splint abutment screw with a splint abutment driver at 30 N·cm.

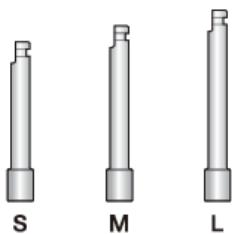

Splint abutment drivers

Tightening torque
30 N·cm



Splint abutment angle type (17° and 30°) mounting

- Mount the splint abutment on the implant body using the pre-mounted abutment carrier.

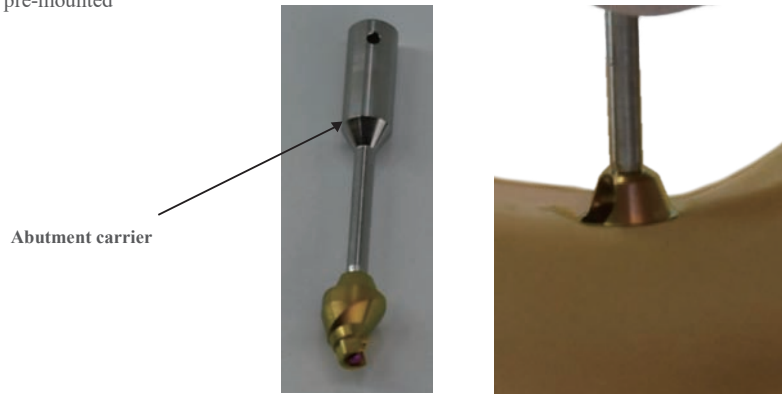

Note

The splint abutment angle type is inclined toward the edge of the hexagon.

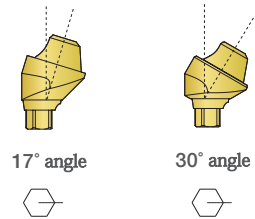

Note

The angular orientation of the angle depends on the orientation of the hexagon on the abutment fitting area of the implant body. Therefore, when implanting the implant body, consider that the hexagon orientation of the implant driver CH matches the intended angle orientation.

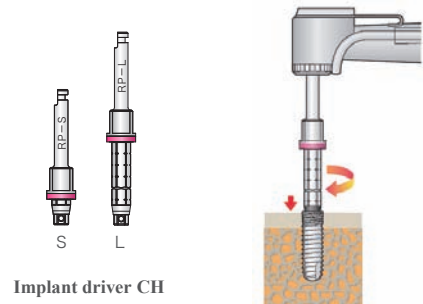

- Use the flex driver CH and CH adapter to lightly tighten the splint abutment angle screw until you feel resistance. Then remove the abutment carrier.

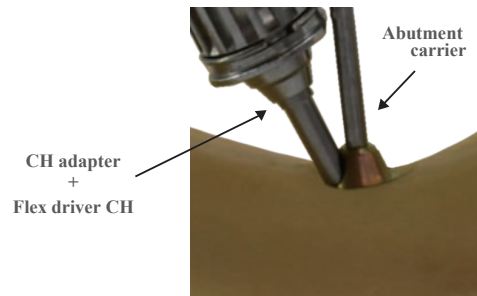
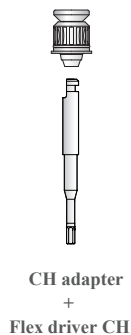

- Tighten the splint abutment angle screw with a flex driver CH at 20 N·cm.

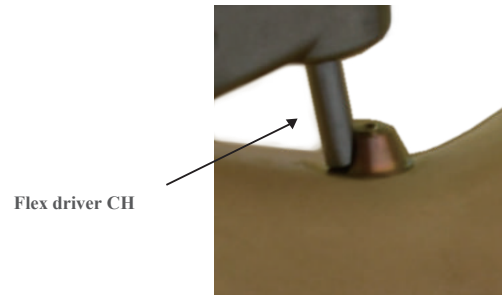
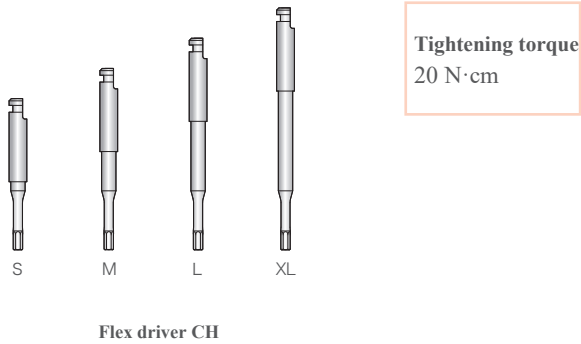

Installation of Splint Healing Cap

- Mount the splint healing cap on the splint abutment and tighten the cylinder screw using the flex driver CH and CH adapter.

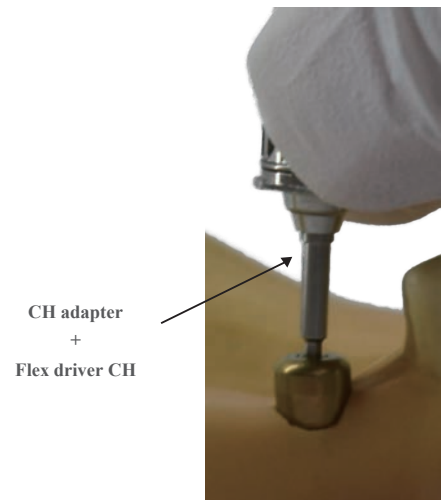

Fabrication of a screw-retained superstructure using a splint abutment

◆ Fabrication of a provisional restoration with a temporary cylinder

Step 1 Adjustment of the temporary cylinder

- Attach the temporary cylinder on an analog and tighten the lab screw using a flex driver.

Technical points

For a single tooth, use temporary cylinder ST (with antirotation mechanism), and for a bridge, use temporary cylinder R (without antirotation mechanism).

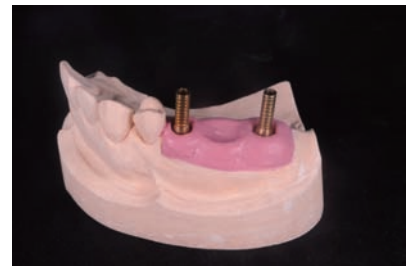
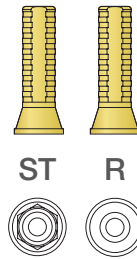

- With reference to the height of the adjacent teeth and the clearance of the opposing tooth, mark the post of the temporary cylinder at an appropriate height and adjust it by grinding as required.

Notes

The cylinder screw head is set 4.3 mm from the platform of the splint abutment. Adjust the height of the post so that the screw head does not protrude.

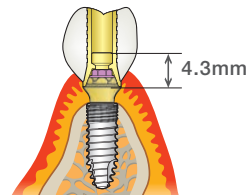

Step 2 Wax-up

- Create a wax-up according to the anatomical form and fabricate a silicon key over it.



step 3 Building up resin

- To prevent resin from flowing into the access hole(s), use Rubber Sep, etc. to seal the access hole(s).

Notes

While sandblasting the temporary cylinder surface, prevent the sandblaster from coming in contact with the fit. Otherwise, the fit will be compromised.

- Replace the fabricated silicon key on the model and pour resin into the silicon key. Subject the temporary cylinder to opacifying treatment with hard resin if the esthetic demand is high.
- Correct the form of the provisional resin restoration.

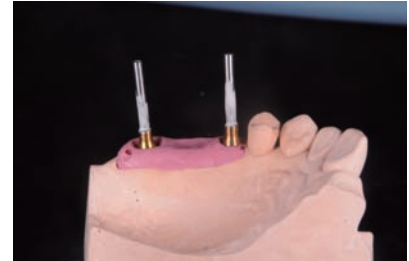

Step 4 Fabrication of the final superstructure

Attach a gold cylinder on an analog and tighten the lab screw using a flex driver CH.

Technical points

For a single tooth, use gold cylinder ST (with antirotation mechanism), and for a bridge, use gold cylinder R (without antirotation mechanism).

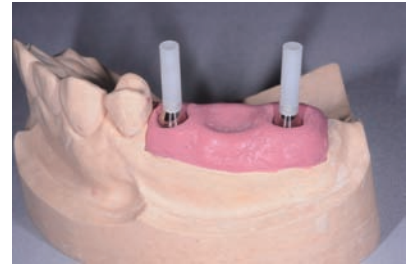
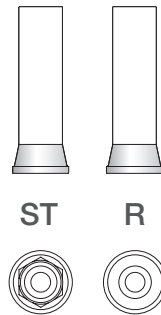

- With reference to the height of the adjacent teeth and the clearance of the opposing tooth, mark the post of the gold cylinder at an appropriate height and adjust the coping by grinding as required.

Notes

Adjust the height of the post without grinding the gold alloy portion.

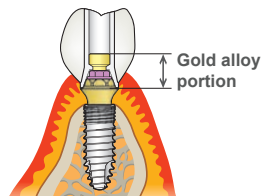

- Create a wax-up and sprue it.



Step 5 Investing/casting

- After spruing and investing the superstructure after wax-up, cast the wax pattern according to the conventional technique.



Step 6 Correction of form/polishing

- Adjust the fitting on the work model.
- Correct the form of the cast superstructure and polish it.
Adequately polish the area that comes in contact with the gingiva.



- One-screw test -

The one-screw test should be performed when a screw-retained superstructure is manufactured or abutments are coupled with a bar attachment.

The one-screw test is used to evaluate the accuracy of the fit during the try-in or attachment of a prosthesis supported by multiple implants. A screw is inserted in one end of the prosthesis to check that the prosthesis does not rise.

If the superstructure and analogs rise, the frame should be cut and connected again by waxing.



2 Cast-on abutment

- ◆ Intended use
 - Fabrication of cement-retained superstructures using custom abutments
 - Fabrication of screw-retained superstructures (single tooth or multiple teeth)

- ◆ Material
 - Gold alloy (Ceramicor, manufactured by CENDRES+METAUX)

- ◆ Criteria for selection
 - Insertion of single-tooth implants
 - Insertion of multiple-tooth implants
 - Applicable even when the clearance of the opposing tooth is inadequate (for screw-retained superstructures)

- ◆ Tightening torque
 - NP 20 N·cm
 - RP 30 N·cm
 - WP 30 N·cm

- ◆ Indicated driver
 - Hexalobular driver

- ◆ Sterilization condition
 - Unsterilized

* Make sure to sterilize an unsterilized component before attaching it to the implant body in the oral cavity.

Cast-on abutment

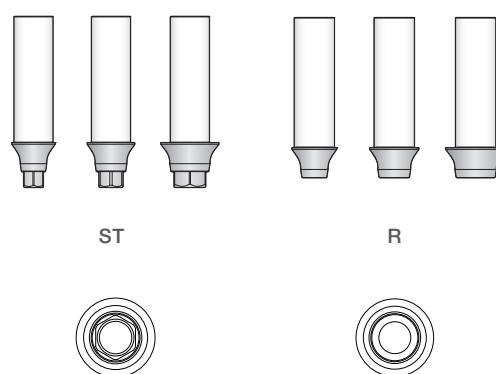

Basic surgical procedure for cast-on abutments**Primary surgery**

- Implant placement
- Attachment of a cover screw or healing abutment

Tightening method

Manual (manual tightening)

Indicated driver

Hexalobular driver SH

Temporary prosthesis

- Provisional restoration (attachment of temporary abutment)

Tightening torque

NP 20 N•cm

RP/WP 30 N•cm

Indicated driver

Hexalobular driver

Final prosthesis

- Attachment of the abutment/final prosthesis

Tightening torque

NP 20 N•cm

RP/WP 30 N•cm

Indicated driver

Hexalobular driver

Variations in cast-on abutment size

(Unit: mm)

| Product drawing | Platform | Diameter of compatible implant (Φ) | Diameter (W) | Cuff height (H1) | Height (H2) |
|-----------------|----------|------------------------------------|--------------|------------------|-------------|
| | NP | 3.2/3.4 | 4.1 | 2 | 14 |
| | RP | 3.7/4.2 | 4.5 | | |
| | WP | 4.7/5.2 | 5.5 | | |

2-1 Precautions for the use of cast-on abutments

- 1) As a standard, an abutment is installed at least 3 months after implant placement in the mandible and at least 6 months after implant placement in the maxilla. Before abutment placement, please ensure that the soft tissues and bone have healed.
- 2) This product is not sterilized.
- 3) Obtain X-ray images as needed and confirm that there is no gap between the abutment and implant body.
- 4) Before attaching the abutment, thoroughly clean the inside of the implant body and eliminate foreign material, including blood.
- 5) A lab screw is used for laboratory work. Because the shape of a lab screw is the same as that of an abutment screw, carefully check the product label before use to avoid confusion.
- 6) The tightening torque for a tightened screw is slightly decreased because of initial plastic deformation of the screw itself. Retightening restores the fastening force, brings the components closer, and prevents loosening. Retighten the abutment screw two or three times.
- 7) Use an alternatively available abutment screw at the time of replacement during maintenance.
- 8) Do not store the products in an area exposed to high temperature, humidity, or direct sunlight. To prevent the risk of infection, never use implant bodies dropped on the floor or contaminated by foreign material such as saliva. Please discard such implants.
- 9) When tightening the abutment or operating a dedicated tool, be careful so that the patient does not accidentally swallow them.
- 10) Do not subject the abutment to excessive force, which can deform or damage it.
- 11) Check the package before opening it. Do not use the abutment, if the package is damaged.
- 12) Do not use any tool other than dedicated ones, otherwise you can damage the implant body.
- 13) Please read the package inserts before use and thoroughly understand the function, method of use, and surgical procedure.

2-2 Fabrication of a screw-retained superstructure using a cast-on abutment

Step 1 Adjustment of the cast-on abutment

- Attach the cast-on abutment to an analog model.

Technical points

For a single tooth, use cast-on abutment ST (with an antirotation mechanism). For multiple teeth, use cast-on abutment R (without an antirotation mechanism).

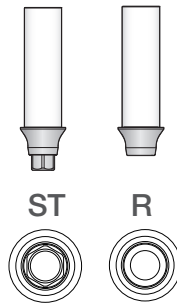

- With reference to the height of the adjacent teeth and clearance of the opposing tooth, perform milling to adjust the post as necessary.

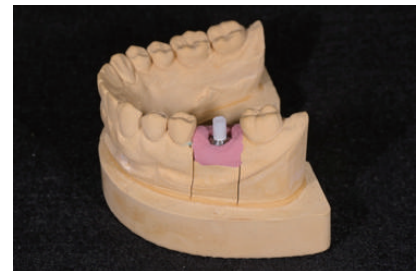

Step 2 Wax-up

- Considering the anatomic form, fabricate a wax-up on the cast-on abutment.



Step 3 Spruing/investing/casting

- Following spruing and investment of the waxed-up superstructure, perform the casting procedure using the conventional technique.

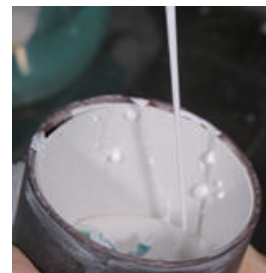

Step 4 Correction of form/polishing

- Correct the form of the cast superstructure and polish it. The procedure is now complete.
In particular, take care while polishing the portion that comes in contact with the gingiva.

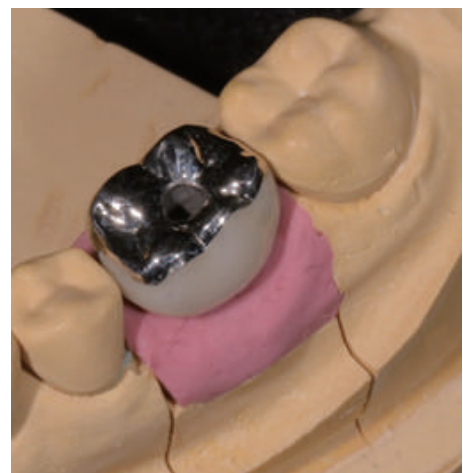

Technical information on the welding technique

Precautions for use of the welding technique

The cast-on abutment and gold cylinder have a high degree of flexibility and can be used for a wide variety of applications. This enables the clinician to create custom abutments and screw-retained superstructures with high precision. During welding, a metal-to-metal bond is formed through the interface reaction (diffusion) of two alloy materials, which takes place when the CENDRES+METAUX Ceramicor (gold alloy) base and the cast alloy are wetted in molten metal.

In the BL implant system, the welding technique is used for the cast-on abutment/gold cylinder.

To ensure secure welding, it is important to pay attention to the conditions and method of use at each step.

Wax-up

- Ensure that you add wax to the cast-on abutment on an analog and do not let the wax flow over the junction.
- Do not use a metal instrument to adjust excess wax because such instruments can damage the gold alloy base.
- Ensure that the wax layer on the gold alloy base is sufficiently thick (at least 0.75 mm).
- Following completion of the wax-up, remove the oil film and excess wax from the joint and inner surface of the implant using a swab.

Spruing

- With regard to the direction of spruing, avoid a sprue that is orthogonal to the long axis of the abutment so that the cast pressure is not directly transmitted to the abutment.
- Consider installing a vent as a measure against back pressure.
- Perform the investment procedure without using a pattern cleaner.

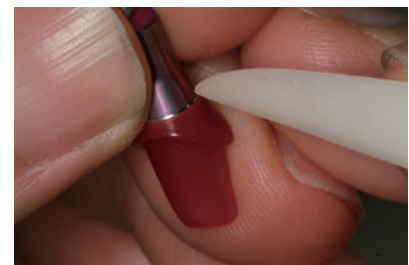
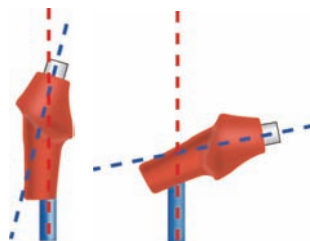

The figure shows a cast-on abutment for TL implants.



The figure shows a cast-on abutment for TL implants.

Investment and ring incineration

- Do not use any investment material of the rapid heating type. Make sure to use an investment material of the conventional heating type.
- Use an investment material that suits the alloy used.
- Before handling the investment material, thoroughly check the manufacturer's instruction manual.
- Be careful about the temperature rise during burning of the ring.

Be careful when using burnout-type plastic, pattern resin, and plastic sprues for cast-on abutments.

During the incineration of resin-based material, the softening temperature is approximately 190°C. The material is expected to swell rapidly at this temperature. This type of swelling can damage the investment material; therefore, avoid rapid heating. Moreover, gradually increase the temperature from room temperature to approximately 300°C.

For the holding temperature and time, check the instruction manual for the investment material being used.

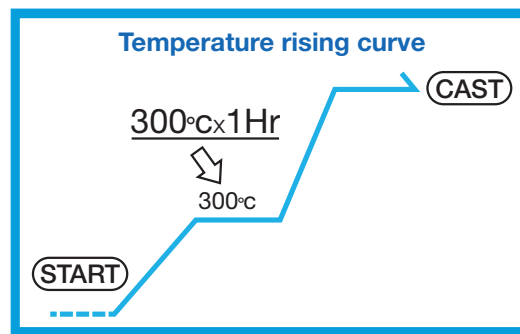

Casting

- Select an alloy for welding from the following: gold alloy for dental casting; ISO 22674:2006 Type 3 and Type 4 equivalent (an alloy with a gold content of 65% or more and a total gold and platinum group element content of 75% or more, or a total gold and platinum group element content of 25% or more and less than 75%).
Use an alloy with an elongation equal to or greater than 5%.
- For a single crown, select a weld body with a maximum height of 12.0 mm and a maximum diameter of 12.0 mm. In addition, ensure that the weld body is 0.75 mm or more in thickness.
When correcting the angle of the welding body, set up the dental axis within 15° to the long axis of the implant.
- Maintain a casting temperature of 1,200°C or lower.
- After casting, let the casting ring stand to cool to a room temperature.
- When removing the welding body from the ring, do not subject it to a strong impact with a hammer or any other device.
- Do not sandblast to remove the investing material. Otherwise, the fit will be compromised.

8. Custom abutment manufactured using CAD/CAM

1 Titanium-based abutment

◆ Intended use

- Fabrication of cement-retained superstructures (single tooth/multiple teeth)
- Fabrication of screw-retained superstructures (single tooth)

◆ Material

- Titanium alloy (Ti-6Al-4V ELI)

◆ Tightening torque

- NP 20N·cm
- RP 30 N·cm
- WP 30 N·cm

◆ Indicated driver

- Hexalobular driver

◆ Sterilization condition

- Non-sterilized

*Before attaching Non-sterilized products to implant bodies in the oral cavity, please sterilize them.

◆ Remarks

- The cuff of a titanium-based abutment has the same shape as the portion of a healing abutment at a height of 3 mm (cuff: 2 mm) for each platform.

Titanium-based abutment



Basic technique for titanium-based abutments

Primary/secondary operation

- Implant placement
- Attachment of cover screw or healing abutment

Tightening method

Manual (manual tightening)

Indicated driver

Hexalobular driver SH

Provisional prosthesis

- Provisional restoration (attachment of temporary abutment)

Tightening torque

NP 20 N·cm

RP / WP 30 N·cm

Indicated driver

Hexalobular driver

Final prosthesis

- Attachment of abutment/final prosthesis

Tightening torque

NP 20 N·cm

RP / WP 30 N·cm

Indicated driver

Hexalobular driver

Variations in the titanium-based abutment size

(Unit: mm)

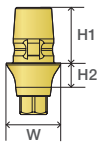
| Product drawing | Platform | Diameter of compatible implant (φ) | Post length (H1) | Cuff height (H2) | Diameter (W) |
|---|----------|------------------------------------|------------------|------------------|--------------|
|  | NP | 3.2/3.4 | 4.6 | 2.0 | 4.1 |
| | RP | 3.7/4.2 | | | 4.5 |
| | WP | 4.7/5.2 | | | 5.5 |

[1] Fabrication of cement-retained superstructures (two-piece abutment)

Step 1 Fabrication of custom abutments and frameworks

- Fabricate a custom abutment and framework using the dental CAD/CAM system, taking into account the relationship with the opposing teeth and design of the prosthesis.

Notes

The head of an abutment screw can have three diameters: NP, 2.0 mm; RP, 2.3 mm; and WP, 2.5 mm.

When fabricating a custom abutment, prepare an access hole after considering the diameter of the screw head for each platform.

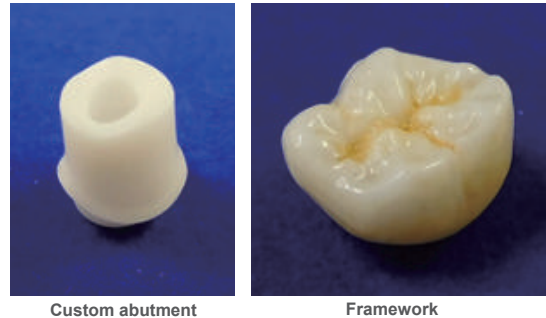

Custom abutment

Framework

Important

Precautions for custom abutment fabrication

Consider the following when fabricating a custom abutment for bonding to a titanium-based abutment.

- Use dental zirconia (an approved and certified product conforming to Type II Class 6 specified in ISO 6872) as a ceramic material for fabrication of a custom abutment.
- Design a custom abutment with a height and diameter of up to 10 mm and allow for angle correction within 15°.
- Set the cement space to 50 μm or less.

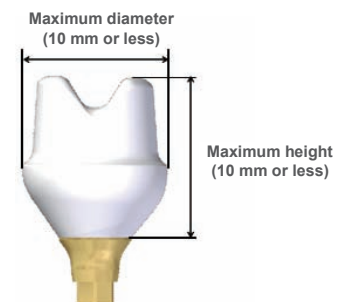

Step 2 Custom abutment bonding

- Clean the surfaces of the manufactured custom abutment and a titanium-based abutment. Then, extraorally bond the custom abutment to the post of the titanium-based abutment using resin cement for dental bonding. Once the cement sets, remove excess by polishing the cement line with a bar for dental laboratory work, in order to achieve a shape that prevents plaque build-up.

Technical points

The post of a titanium-based abutment has a projection for retention. Check whether the manufactured custom abutment accurately fits the post through try-in.

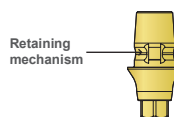

Recommended cements for dental bonding

For bonding a custom abutment, use the resin cement "ResiCem" for dental bonding (manufacturer/seller: Shofu Inc.). For details, refer to the instruction manual for "ResiCem."

Step 3 Bonding framework

Bond the cleaned framework to the custom abutment according to the conventional technique.



[2] Fabrication of a screw-retained superstructure (one-piece abutment)

Step 1 Fabrication of the framework

- Fabricate the framework using the dental CAD/CAM system, keeping in mind the relationship with the opposing teeth and design of the prosthesis.

Notes

The head of an abutment screw can have three diameters: NP, 2.0 mm; RP, 2.3 mm; and WP, 2.5 mm. When fabricating a framework, prepare an access hole after considering the diameter of the screw head for each platform.

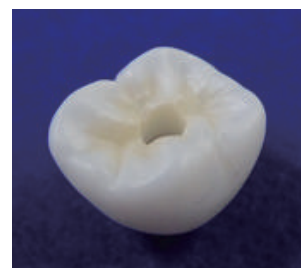

Step 2 Bonding framework

Bond the cleaned framework to the post of the titanium-based abutment using the conventional technique.



9. Overdenture

1 Overdenture

In cases with significant alveolar ridge resorption, an implant-supported overdenture aids in stability. An overdenture requires lesser implants compared with a cement-retained or screw-retained bridge in edentulous cases. It is also effective for cases where implant body insertion in the molar region is difficult.

The FINESIA products are compatible with the attachment types used for implant-supported overdentures, including [1] bar and [2] ball attachments.

[1] Bar attachment

For an implant-supported overdenture, a bar attachment (stress-breaking) can be used to disperse load to the implant bodies and mucosae. A bar attachment is superior for connecting the implant bodies and is resistant to oscillation and rotation of the denture. However, when a bar attachment is used, a certain distance is required between the bar and the denture because the bar attachment is placed above the alveolar ridge mucosa and the sleeves are set inside the denture. Therefore, it is difficult to use a bar attachment in cases where adequate clearance cannot be ensured.

[2] Ball attachment

A ball attachment is removable and consists of a ball abutment and a metal housing (female part). The female with a spring structure fits the ball of the abutment to maintain a retentive force.

Although the implant bodies should be inserted in parallel with each other, if the angle between implants is not larger than 40°, the denture is allowed to rotate. In cases where implant bodies must be inserted at acute angles, other attachments such as bar attachments should be used.

2 Splint abutment

◆ Intended use

- Fabrication of screw-retained superstructures (single tooth or multiple teeth)
- Fabrication of overdentures

◆ Material

- Splint abutment Titanium alloy (Ti-6Al-4V ELI)
- Splint healing cap Titanium alloy (Ti-6Al-4V ELI)
- Temporary cylinder Titanium alloy (Ti-6Al-4V ELI)
- Gold cylinder Gold alloy (Ceramicor: manufactured by Cendres+Métaux)

◆ Selection criteria

- Insertion of single-tooth implants
- Insertion of multiple-tooth implants

*Splint abutments are recommended for the insertion of multiple-tooth implants.

◆ Tightening torque/method

- Splint abutment (straight) 30 N·cm
- Splint abutment (angle) 20 N·cm
- Gold cylinder/temporary cylinder 20 N·cm
- Splint healing cap Manual (manual tightening)

◆ Indicated driver

- Splint abutment (straight) Driver for splint abutment
- Splint abutment (angle) Flex driver CH
- Splint healing cap Flex driver CH + CH adapter
- Temporary cylinder Flex driver CH
- Gold cylinder Flex driver CH

◆ Sterilization condition

- Splint abutment Sterilized
- Splint healing cap/gold cylinder /temporary cylinder Non-sterilized

*Before attaching Non-sterilized products to implant bodies in the oral cavity, please sterilize them.

Splint abutment



Angle 17°



Angle 30°

Gold cylinder



ST



R



Temporary cylinder

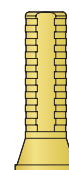

ST

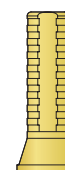

R



Splint healing cap



Basic technique for splint abutments**Primary operation**

- Implant placement
- Attachment of cover screw or healing abutment

Tightening method

Manual (manual tightening)

Indicated driver

Hexalobular driver SH

Basic technique for splint abutments (secondary operation)

- Attachment of splint abutments

Tightening torque

Straight 30 N·cm

Angle 20 N·cm

Indicated driver

Straight-type Driver for splint abutment

Angle-type Flex driver CH

Provisional prosthesis

- Provisional restoration (temporary cylinder attachment)

Tightening torque

20 N·cm

Indicated driver

Flex driver CH

Final prosthesis

- Final prosthesis attachment

Tightening torque

20 N·cm

Indicated driver

Flex driver CH

Variations in the splint abutment size

● Straight-type

(Unit: mm)

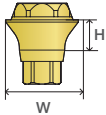
| Product drawing | Platform | Diameter of compatible implant (φ) | Cuff height (H) | Diameter (W) |
|---|----------|------------------------------------|-----------------|--------------|
|  | RP | 3.7/4.2 | 1.0 | 4.8 |
| | | | 2.0 | |
| | | | 3.0 | |
| | | | 4.0 | |
| | | | 5.0 | |
| | WP | 4.7/5.2 | 1.0 | |
| | | | 2.0 | |
| | | | 3.0 | |
| | | | 4.0 | |
| | | | 5.0 | |

● Angle-type

(Unit: mm)

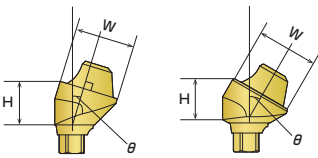
| Product drawing | Platform | Diameter of compatible implant (φ) | Cuff height (H) | Diameter (W) | Angle (θ) |
|---|----------|------------------------------------|-----------------|--------------|-----------|
|  | RP | 3.7/4.2 | 2.5 | 4.8 | 17° |
| | | | 3.5 | | |
| | | | 4.5 | | |
| | | | 4.5 | | |
| | WP | 4.7/5.2 | 3.5 | | 17° |
| | | | 3.0 | | |
| | | | 17° | | |
| | | | 30° | | |

Variations in the temporary cylinder size

(Unit: mm)

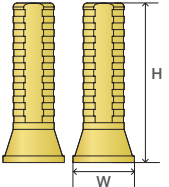
| Product drawing | Length (H) | Diameter (W) |
|---|------------|--------------|
|  | 12.0 | 4.8 |

Variations in the gold cylinder size

(Unit: mm)

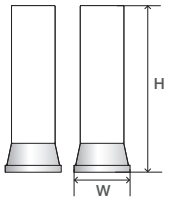
| Product drawing | Length (H) | Diameter (W) |
|---|------------|--------------|
|  | 14.5 | 4.8 |

Variations in the splint healing cap size

(Unit: mm)

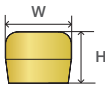
| Product drawing | Height (H) | Diameter (W) |
|---|------------|--------------|
|  | 4.3 | 5.3 |

How to fabricate an overdenture with a bar attachment

Step 1 Fabrication of a work model

- Fabricate an analog model with analogs for a splint abutment For a bar attachment, use transfer coping R. Record an impression using the open tray technique for bridges.
To record an impression using the closed tray technique, split the framework and fix after try-in in the oral cavity.



Step 2 Placement of artificial teeth

- Place the artificial teeth on the analog model.



- Obtain a silicon impression.



Step 3 Waxing up the bar attachment

- Attach the gold cylinders to analogs and tighten the lab screws using a screwdriver. Use gold cylinder R.



- Set the artificial teeth on the core impression recorded for replication of the placement status. Consider the denture space and mark the sleeves of gold cylinders at an appropriate height and adjust them by grinding as required.



- Install the bar frame.

Technical points

- The bar structure for the front teeth must be perpendicular to the midline of the alveolar ridge.
- Basically, set the bar parallel to the occlusal plane.

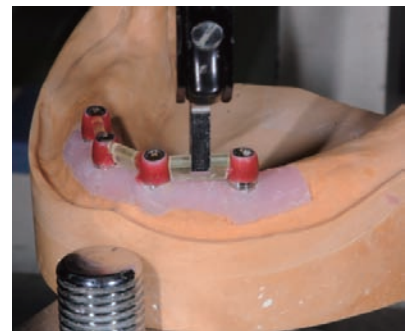

- Set the artificial teeth on the core impression and check the denture space for the bar frame.



- Wax up the bar attachment.

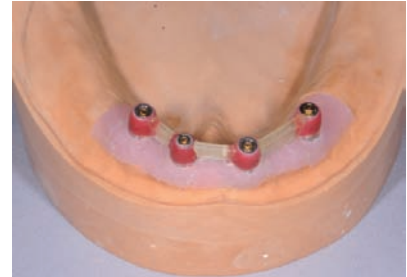

Step 4 Spruing/investing

- Sprue the superstructure after wax-up.



- Thoroughly clean the superstructure after wax-up and before investing.
Clean with a swab or brush moistened with alcohol for the complete removal of residual wax.



Step 5 Casting

Cast a framework in a general manner and remove the investing material.



Step 6 Correction of form/polishing

- Adjust the fitting of the framework on the work model and polish it to fabricate a bar attachment.

Technical points

Perform the one-screw test. If the superstructure and analogs rise, cut the frame and connect the pieces again by waxing.

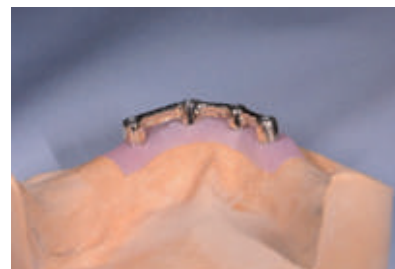

Step 7 Bar clip attachment

- Attach bar clips (for retention) on the inner surface of the denture according to the instruction manual for the bar attachment system being used.

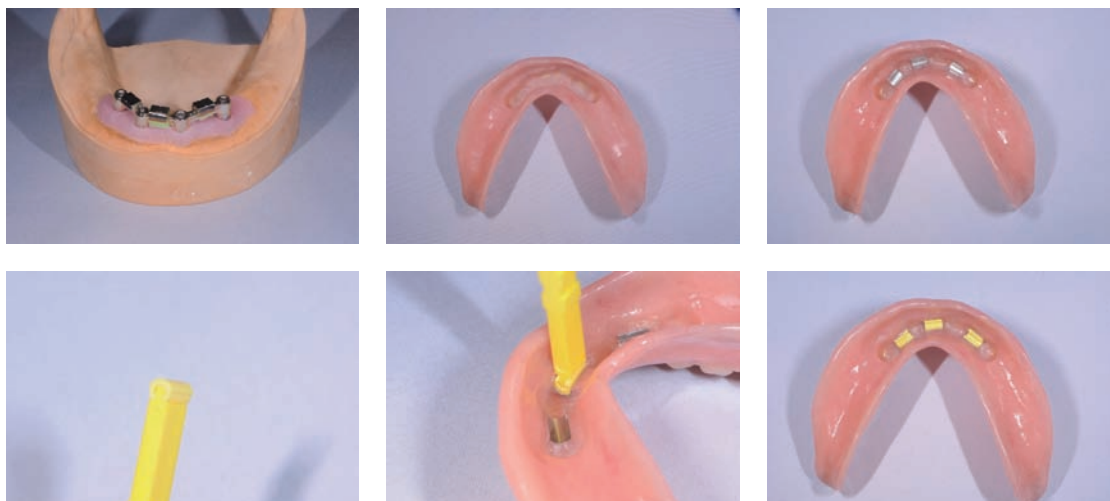

- The below images show a completed overdenture with a bar attachment.

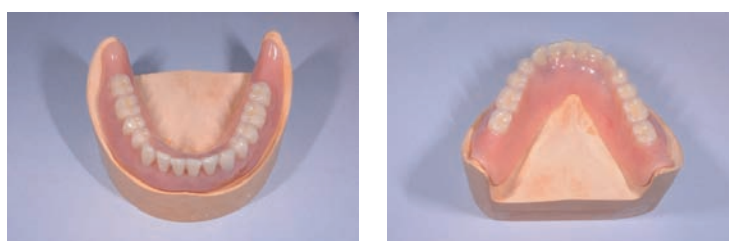

3 Ball abutment

◆ Intended use

- Fabrication of an overdenture with ball attachments

*Ball abutments can be used in combination with the designated attachment



Ball abutment

◆ Material

- Titanium alloy (Ti-6Al-4V ELI)

◆ Selection criteria

- When BL fixture RP with ϕ 3.7 mm or ϕ 4.2 mm is used or when BL fixture WP with ϕ 4.7 mm or ϕ 5.2 mm is used
- When two or more implant bodies are inserted in the alveolar ridge
(Determine the number of implant bodies to be inserted, keeping in mind the age and condition of the patient.)

◆ Tightening torque

- 30 N·cm

◆ Indicated driver

- Ball abutment driver

◆ Sterilization condition

- Non-sterilized

*Before attaching Non-sterilized products to implant bodies in the oral cavity, please sterilize them.

Basic technique for ball abutments

Primary/secondary operation

- Implant placement
- Attachment of cover screw or custom healing abutment

Tightening method

Manual (manual tightening)

Indicated driver

Hexalobular driver SH

Final prosthesis

- Attachment of abutment/final prosthesis

Tightening torque

30 N·cm

Indicated driver

Ball abutment driver

*Attach the ball abutment in the secondary operation.

Variations in the ball abutment size

(Unit: mm)

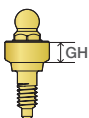
| Product drawing | Platform | Diameter of compatible implant | Cuff height (GH) |
|---|----------|--------------------------------|------------------|
|  | RP | 3.7/4.2 | 1.0 |
| | | | 3.0 |
| | | | 5.0 |
| | WP | 4.7/5.2 | 1.0 |
| | | | 3.0 |
| | | | 5.0 |

How to fabricate an overdenture with ball attachments

Step 1 Fabrication of a work model

- Record an impression of the ball abutments, fit the analogs on the impression surface, and fabricate a work model with superhard plaster.



Step 2 Placement of housings

- Block out quick-cure resin to prevent it from flowing into the designated attachment housings.
 - * For details on how to operate the designated attachments, refer to the instruction manual.



Technical points

Place duplication aids in the ball abutment analogs, record a duplicating impression, and fabricate a duplicate model. The positional relationship of the designated attachment housings can be marked as a guide on the inner surface of the denture by polymerizing the denture on the duplicate model.

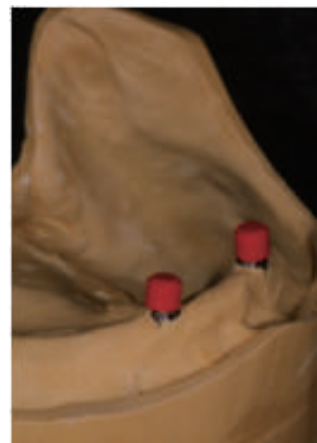

- Fix the designated attachment housings on the inner surface of the denture using quick-cure resin.



- Place lamellae retention inserts in the housings fixed on the inner surface of the denture using a screwdriver/activator.



- The photos show a completed overdenture with ball attachments.



KYOCERA Asia Pacific Pte. Ltd.

Medical division

298 Tiong Bahru Road #13-03/05 Central Plaza Singapore 168730

TEL : 65-6271-0500 FAX : 65-6271-0600

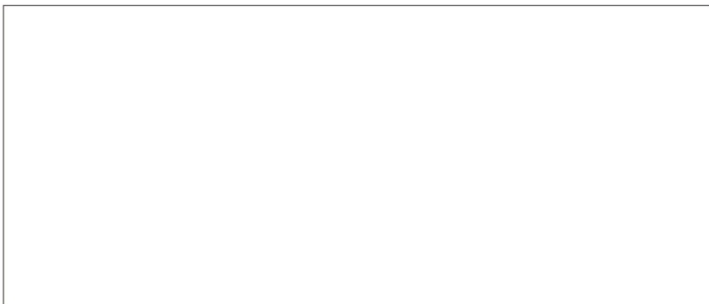

FINESIA is a registered trademark of KYOCERA Corporation.

FINESIA is a trademark of KYOCERA Corporation.

The information included in this manual is as of January 2019.

Reproduction or copying of this manual, in whole or in part,
without permission is prohibited.